



retail cata

retail catalogue

retail catalogue

retail catalogue 2023

retail catalogue 20

retail catalogue

retail catalogue

retail catalogue 2023



retail catalogue 2023



# IN-STORE DISPLAYS

Catching your customers attention and quickly expressing the features and functions of AutoPot is an essential part of driving sales. With our new illustrated point of sale fixtures you get a massive head start in introducing the range.

These sturdy displays are available to our all stockists on request. Contact your rep now for further details

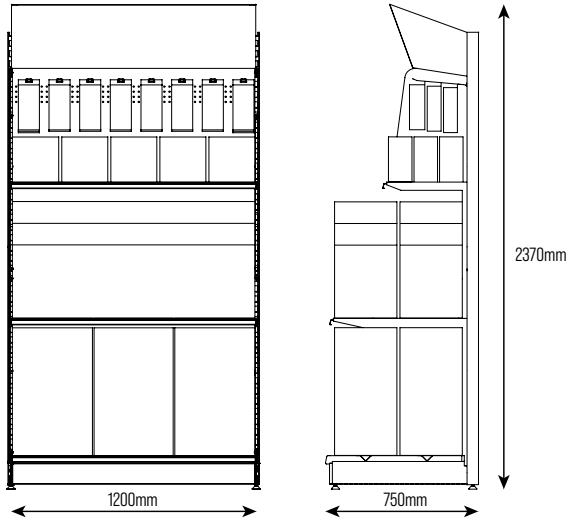

*AutoPot In-Store Displays can be adjusted to accommodate a wide range of products - including our new, fully illustrated retail-boxed kits and systems - see below*



## SALES DRIVING

Fully illustrated retail packaging showing products in action allows your customers to browse, appreciate, and approach you with confidence - vastly improving transactions.

## SUSTAINABLE

We've introduced sustainably sourced cardboard, organic inks, and complete biodegradability to our retail packaging - the only responsible way forward.

## FEATURE PACKED

For first-timers a watering system can seem daunting. All our packaging now features quick set-up guides and QR links to assembly videos - making AutoPot easy to grasp.



# CONTENTS

<b>In-Store Displays</b>	<b>2</b>
<b>AQUAvalve5</b>	<b>4 - 5</b>
<b>Growers Tips</b>	<b>6 - 13</b>
<b>Watering Systems</b>	<b>14 - 39</b>
1Pot Systems	14 - 17
easy2grow Systems	18 - 21
XL Systems	22 - 25
XL FlexiPot Systems	26 - 29
XXL35 & XXL50	30 - 33
Tray Systems & FlexiPot	34 - 37
Tray2Grow	38 - 39
<b>Kits &amp; Accessories</b>	<b>40 - 51</b>
Pot Divider & Strawberry Topper	40
Propagation Lids & Systems	41
easy2Propagate	42 - 43
easy2GO & CocoMat	44
PlantSkirt	45
AQUAplates	46
AQUAbox Straight & Spyder	47
AirDome, Pumps & AirBase	48 - 49
CO2 Generator	50
Garden Trays	51
<b>Reservoirs</b>	<b>52 - 55 &amp; 61</b>
FlexiTank & Tapless FlexiTank	52 - 53
FlexiTank Pro	54 - 55
Plastic Reservoirs	61
<b>Modules, Pots, &amp; Trays</b>	<b>56 - 57</b>
<b>Fittings, System/AQUAvalve Spares &amp; Pipe</b>	<b>58 - 61</b>
<b>Root Control</b>	<b>61</b>
<b>The Source</b>	<b>62 - 63</b>
<b>Rapid Roots &amp; Liquid Feeds</b>	<b>64</b>
<b>BioTabs Organic Nutrients</b>	<b>65</b>
<b>AutoPot Growers &amp; Store Resources</b>	<b>66 - 67</b>





## POWER-FREE

AQUAvalve5 is supplied with every AutoPot Watering System. Once connected to the water supply, the AQUAvalve5 will control the flow of water to the plants by simple gravity pressure from a reservoir or tank of any size. No pumps, mains water pressure, electricity or timers are ever required.

## A FASTER FLOW

The needs of growers are ever-evolving, served by an increasingly diverse range of nutrients. With a 5mm inlet, AQUAvalve5 rises to the challenge of delivering the widest range of nutrients in a faster flow for a quicker fill, maximising system efficiency. Maintenance is reduced and the risk of blockages minimised.

## PLANT CONTROLLED

AQUAvalve5 is an exceptionally responsive means of feeding. It opens to supply water to a 20mm depth and then closes. Once the plants have used that supply the AQUAvalve5 reopens to repeat the cycle. No need to second guess plant requirements, compensate for conditions or recalibrate unnecessary pumps or computers.

# AQUAvalve<sup>5</sup>™



SUITABLE FOR USE WITH MINERAL OR ORGANIC LIQUID FERTILISERS

PLANT CONTROLLED - THE ULTIMATE IN RESPONSIVE IRRIGATION

GRAVITY-FED - REQUIRES NO PUMPS, TIMERS, COMPUTERS, OR RUNNING WATER

## ANATOMY

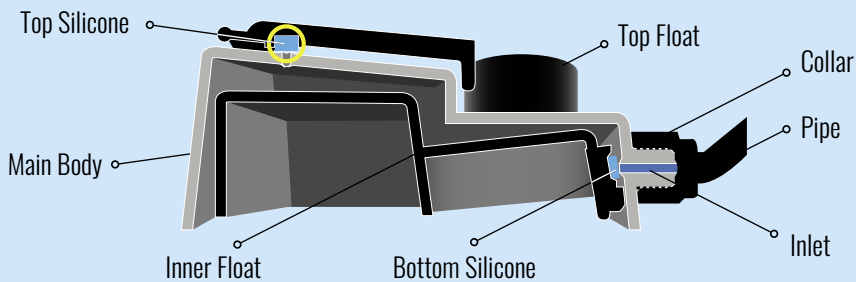

## OPERATION

FOR AQUAVALVE CARE AND ADVICE SEE PAGE 13

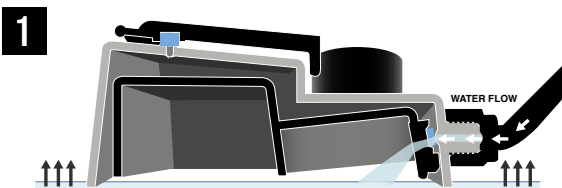

Once the AQUAvalve is positioned in a tray and connected to the water supply and the tap turned on, water will begin to flow into the tray through the AQUAvalve nozzle. The Inner Float will rise a little but the Top Float will remain in position, keeping the hole sealed on the Main Body and preventing the Inner Float from rising further.

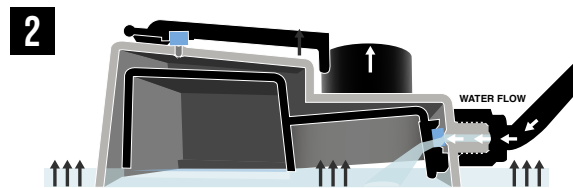

Trapped air inside the Main Body is unable to escape as the silicone in the Upper Float is creating a seal on the Main Body, water continues to enter into the tray as the Inner Float is unable to shut off due to the trapped air.

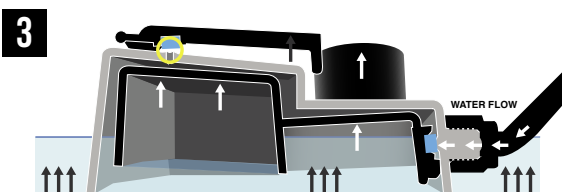

Once the water reaches 20mm (half way on the AQUAvalve collar) the Upper Float will lift allowing the trapped air inside the Main Body to escape and simultaneously the Inner Float will rise and cut off the incoming water.

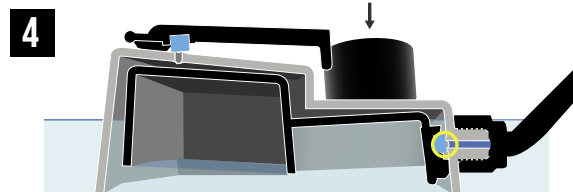

As the plants consume the nutrient solution the Top Float begins to drop back down re-sealing the hole on the Main Body creating an air tight seal.

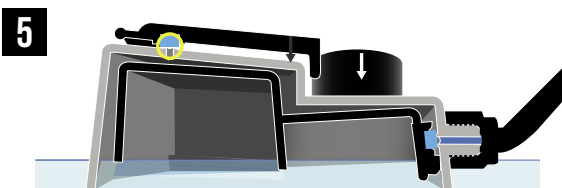

The sealing of the Main Body ensures that there is an air tight seal which in turn creates a vacuum inside the Main Body, this prevents the Inner Float from dropping and preventing any further nutrient solution from entering.

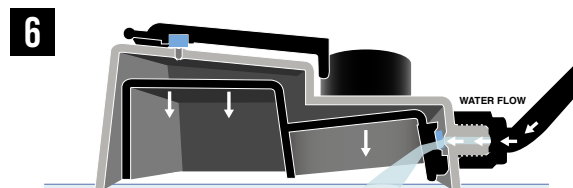

Once the nutrient solution drops below the Main Body of the AQUAvalve the surface tension of the water around the AQUAvalve Main Body will break, this can take up to an hour. The vacuum in the Main Body is then released and the Inner Float drops to a position where the inlet can reopen and the filling process begins again.

### STEP 1: ROOT CONTROL

All AutoPot Watering Systems and Modules are supplied with root control. Depending on the system or module, root control may include some combination of PotSock, Root Control Disc (RCD) and Marix Disc. These are used in the following configurations:

- 1POT:** Marix Disc in pot & RCD in tray (copper face up)
- XL FlexiPot:** PotSock on base of pot (copper face up)
- EASY2GROW:** Marix Disc in pot & PotSock on base of pot (copper face up)
- 1POT XL:** RCD in pot (copper face down)
- NB:** If growing aggressive plants we suggest using a RCD in the pot (copper face down) & PotSock on the base of the pot (copper face up)



### STEP 2: SUBSTRATE CHOICE

A vast range of substrate options are viable with AutoPot. The following represent good examples of substrates that provide the requisite air retention and capillary action. Use quality substrates from reputable brands and ensure the mix is absorbent, light and fluffy. Ensure Clay Pebbles are pH stable or that they have been fully stabilised for at least 48hrs prior to use.



### STEP 3: ADDING SUBSTRATE

For good drainage we recommend an AirBase (p.49) in each pot. Alternatively a 2.5cm base layer of pH stable clay pebbles, pea gravel, or Growstones may be used.

#### FIRST ADD A BASE FOR DRAINAGE



If using AirDomes place the AirDome on the Root Control Disc, or Marix Disc inside the pot and fit the AirBase on top / pour in clay pebbles, gravel, or Grow-Stones to the height of the AirDome.

#### ADD SUBSTRATE UNTIL 1-2" / 2.5-5CM FROM TOP OF THE POT

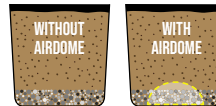

Place your choice of substrates into the pot. Fill until substrate is 2.5-5cm below the top.

### STEP 4: PLANT CHOICE

Always ensure an established plant is used when potting up. Don't place small seedlings directly into the pots. As a general rule:

- easy2grow 2.2gal/8.5l - **Min. plant height 6"/15cm**
- 1Pot 3.9gal/15l - **Min. plant height 9"/22.5cm**
- XL/FlexiPot 6.6gal/25l - **Min. plant height 12"/30cm**

#### ONLY POT UP ESTABLISHED PLANTS



Pot up and with the pot outside the tray, water each pot through. When you see water draining from the bottom of the pot, stop. Allow the pot to drain for 15 mins.

#### HAND WATER POTS



**OUTSIDE OF TRAYS AND ALLOW TO DRAIN**  
Before putting pots into trays clean the bottom and sides of each pot to help ensure the AQUAvalve remains clean and free of substrate.

### STEP 5: SYSTEM ACTIVATION

At this point the system SHOULD NOT be turned on, allow the plants to establish first. As a guide allow:

- 5-7 days** for easy2grow 2.2gal/8.5L
- 7-12 days** for 1Pot 3.9gal/15L
- 10-14 days** for XL/FlexiPot 6.6gal/25L

#### DO NOT SWITCH THE WATERING SYSTEM ON INITIALLY



During the rooting phase the roots will take up the initial "through-watering" and extend to seek out further moisture. Do not water again until day 5-10 of the rooting phase.



#### ALLOW PLANTS TIME TO ESTABLISH IN AUTOPOT POTS

Once you're happy the plants have rooted, turn the system on. Feeling the weight of the pots will give you an idea. If heavy plenty of moisture remains to be absorbed by developing roots, if light switch on.

### STEP 6: AIRDOME ACTIVATION

#### DO NOT SWITCH ON AIRDOMES FOR 2-3 WEEKS



If using AirDomes do not activate them straight away, allow 2-3 weeks for the plants to establish before air is blown into the root zone. Always ensure that warm air is blown into the root zone, temperatures between 18°C - 21°C are perfect. Never blow cold or hot air into the root zone.

#### ONLY BLOW WARM AIR - NEVER HOT OR COLD



If using air domes: place air pumps away from cold floor surfaces and, if the night temperatures in your grow space drop, use a timer to turn off the pump at night.

### STEP 7: NUTRIENT CHOICES & FLUSHING

AutoPot Watering Systems can be used with organic or mineral nutrients. As with all watering systems, care must be taken when using nutrients, especially in the case of organics. For full details of nutrient use and suitability see Nutrient Guides on pages 8-9. Do not attempt feeding without first consulting these guides.

Flushing is NOT necessary with food crops. With other crops flushing FROM ABOVE is NOT necessary, simply supply plain water from the reservoir to the modules for the last 10-14 days. DO NOT pour water through the top of the pots. Salt build up occurs in the top 1"/2.5cm of the substrate, where it has no detrimental effect on plant growth. Pouring water through the pot at the flushing stage may damage roots due to the toxicity of the salt build up at the top of the substrate.

**SUBSTRATE INFO - PAGE 7**

**NUTRIENT USE INFO - PAGES 8-9**

**PROPAGATION INFO - PAGES 10-11**

**RESERVOIRS & WATER INFO - PAGE 12**

**SYSTEM MAINTENANCE INFO - PAGE 13**

## ESSENTIALS

AutoPot Watering Systems are extremely versatile and can be used with the growing medium / substrate of your choice. In growing trials we have cultivated plants in a vast range of substrates from coral to denim and even pumice stone! Whatever substrate you decide to use make sure the mix is absorbent, light, fluffy and free draining. An ideal substrate for use with AutoPot is a 50% mix of perlite or clay pebbles with either soil or coco. The following guidelines and examples may provide a good basis for substrate success.

- For good drainage we recommend an AirBase (p. 49) in the base of each pot. Alternatively a 2.5cm layer of pH stable clay pebbles, pea gravel, Growstones may be used.
- Whether they are used at the bottom of the pot as additional drainage or as part of a mix, clay pebbles MUST be pH stable. Be aware that certain brands are NOT pH stable and will increase the pH of the water in the tray; this will negatively affect plant growth. To stabilise pebbles soak them in pH 5.0 water for 48hrs, then pour off water. DO NOT RINSE.
- Pay close attention to manufacturers instructions where preparation of media is concerned.
- Always use a good quality soil or coco from a reputable brand. Look for coco that has been buffered and stabilised. If unsure, pot up and pour approx 10L of pH 5.6 water and ¼ strength feed through each pot - this will instantly stabilise the coco. Allow to drain thoroughly before use.
- Peat-based composts will compress if used alone, reducing the oxygen content in the root zone. Mix in perlite/clay pebbles/gravel to lighten the compost and improve aeration.

Consider that, though rich, peat can compress to virtual solidity. On the other hand Perlite will never compress. Try to create a mix that balances richness with aeration.

## SUBSTRATE EXAMPLES & KEY QUALITIES

### COCO / CLAY PEBBLES

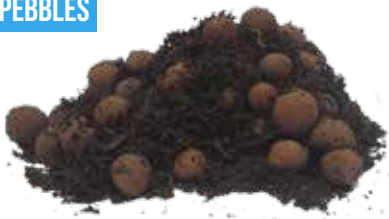

Coco represents a natural, free-draining substrate that can be enhanced with beneficial bacteria and fungi to strengthen the root-zone and accelerate plant growth. The porosity and texture of the pebbles aids water retention, drainage and root-zone oxygenation.

### COCO / PERLITE



Irregular, porous and rough surface textures such as those found on perlite granules provide aeration, superb water retention and also excellent drainage. Combined with the natural benefits and microbial enhancements available to coco, such mixes can give great results.

### COCO / GROWSTONES



Growstones are made from recycled glass and are engineered to provide high porosity, improved aeration and better drainage of the root zone, while retaining water well. Growstones are alkaline and must be pH stabilised before use. Coco adds an active element to the mix by supporting bio-activity and, it is claimed, by delivering nutrients in synch with the plants requirements.

### ROCKWOOL / CLAY PEBBLES



As it is derived from rocks Rockwool is inert and doesn't withhold or repel nutrients selectively in the way that some plant-based substrates can. Therefore it will deliver your nutrient solution in its purest form. However it will require buffering or stabilising in advance of use. Pebbles provide drainage and water retention.

### SOIL / CLAY PEBBLES



Soil is an excellent medium for supporting bio-activity and soil-based substrates are available to a vast number of specifications. A complimentary medium is essential in order to provide drainage, aeration, and prevent compression in the root zone. Clay pebbles are an ideal choice.

### SOIL / PERLITE



Combining any one of the huge range of soil-based grow media with perlite can produce a wonderfully diverse, active, and airy mix. Water is retained perfectly whilst still free to drain and the risk of compacting is minimised.

## MINERAL NUTRIENTS

If mineral feeding is selected, the liquid or soluble mineral nutrient is simply added to the water in the reservoir in a controlled manner and fed via the pipework to the AQUAvalves in the module trays. From there the plants take up the water/nutrient solution as and when they require it. Feed according to nutrient producers' guidelines.

## ORGANIC NUTRIENTS

We recommend the following techniques when using organics with AutoPot Watering Systems - see below for Reservoir Feeding and opposite for Pot Feeding. The arrival of AQUAvalve5 has revolutionised the way in which organics can be fed through AutoPot Watering Systems. For the first time, we can recommend almost constant feeding of liquid organic nutrients, additives, and boosters in solution via the reservoir and pipework. It should be noted that this applies only to systems equipped with AQUAvalve5 and 9mm pipe and fittings. Earlier model AQUAvalves with 6mm pipe and fittings cannot feed liquid organics in solution via the reservoir and pipework on a constant basis. The wider apertures of fittings and pipework on AQUAvalve5 equipped systems produce vastly increased flow rates that practically eliminate potential blockages.

## ORGANICS - RESERVOIR FEEDING

Supply of liquid organic feeds from the reservoir via pipework. **Only applicable to AQUAvalve5 equipped systems with 9mm pipework and fittings.**

**Uses:** Employed by organic growers who wish to simplify and automate to the greatest possible degree. Ideal for confined spaces, large numbers of modules and max. automation.

**Requirements:** Watering system fitted with flush taps at ends of pipework runs. Reservoir to supply liquid organic feed in solution for the duration of the grow. Liquid organic feed.

### Step 1. Setting Up

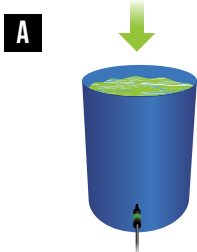

**A** Fill reservoir with water and liquid organic nutrient. Follow nutrient producer's directions when adding feed.

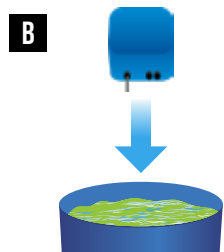

**B** A water pump should be used in the reservoir to keep the solution moving. It should not be necessary to run the pump constantly. 15mins every 2hrs is ideal.

### Step 2. Once the reservoir has emptied

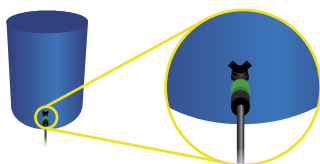

**A** Switch the reservoir off.

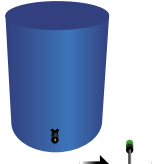

**B** Disconnect the reservoir.



**C** Clean the reservoir inside. Clean the water pump and inline filter. Reconnect.



**D** Refill with plain water only.

### Step 3. Flush the pipework



**A** Switch the reservoir on.



**B** Place the flush taps at the ends of pipework runs into a container / safe drainage.

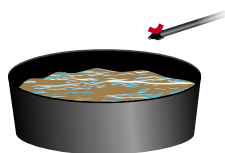

**C** Open flush taps for 30-60 secs. Allow plain water to flow out until it runs clear



**D** Close flush taps. Feed plants on plain water from reservoir for 24 hours.

### Step 4. 24hrs after flushing

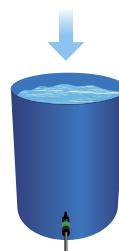

**A** Top up the reservoir with water as necessary.

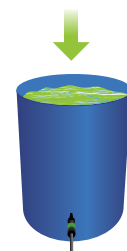

**B** Add liquid organic feed again to correct dosage. Repeat.



Those wishing to grow organically with soil-based nutrients can also do so with AutoPot Watering Systems by Pot Feeding

## ORGANICS - POT FEEDING

Use organic time release tabs, organic soils and/or bacteria in the pots. Use the reservoir and pipework to supply water only during the useful lifespan of the soil-based nutrients. Then, if required, for latter stages of growth hand feed organic feeds/teas directly into the trays or employ Reservoir Feeding (see Reservoir Feeding opposite) via the reservoir and pipework. Organic soils, bacteria and/or soil-based time-release tabs may become depleted after 5-7 weeks. The lifespan of soil or soil-based nutrients will depend on the type of plants being grown and the size of the pot being used. Regardless, an organic liquid supplement may become necessary during the latter stages of growth.

**Uses:** Employed by those wishing to maximise control, customisation and/or use a variety of feed types including organic time release tabs/organic soils and/or bacteria in the pots with teas or organic feeds in latter stages.

**Requirements:** Watering system and reservoir. Reservoir supplies only plain water for the duration of the grow unless switching to Reservoir Feeding for latter growth stages.

Organic time release tabs/organic soils and/or bacteria in the pots.

Organic teas/boosters/feeds if Hand Feeding latter growth stages.

If Reservoir Feeding in latter growth stages see **Reservoir Feeding Requirements** (opposite).

## ORGANICS - POT FEEDING TECHNIQUE

### Step 1. Potting Up and Setting Up

- When potting up use organic soils and/or add bacteria and/or organic time release tabs of your choice to the substrate. Reservoir supplies your plants with water only.



### Step 2. If useful lifespan of soil-based nutrients has elapsed

- Either Reservoir Feed. See Reservoir Feeding section (overleaf) for details.
- Or Hand Feed (see below) directly into module trays

### Step 3. Hand Feed organics directly into the trays - Once every 5-7 days

- Switch Reservoir off and allow module trays to run dry - approx 12hrs

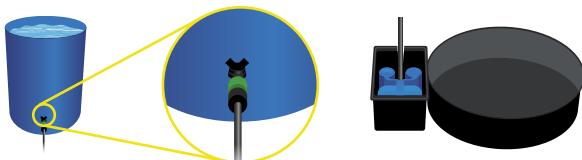

### Step 4. 12hrs after switching off Reservoir

- Prepare the organic solution of your choice

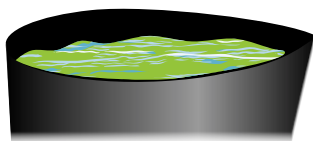

### Step 5.

- Using a small watering can or jug, pour the solution in a controlled manner next to the AQUAvalve, NOT ON THE AQUAvalve

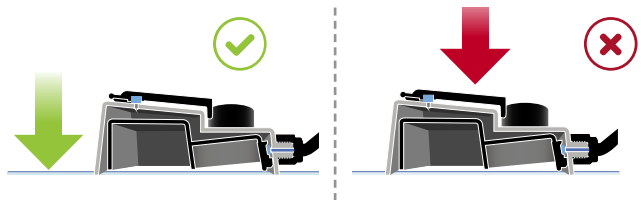

- Fill the tray to the point where the pipe enters the tray and stop
- DO NOT pour the solution into the top of the pot as you will potentially risk flooding the tray and growing area

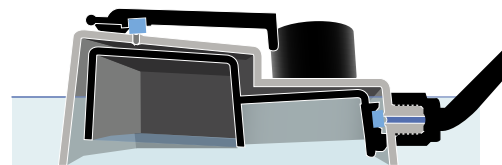

- Leave the solution to be consumed by the plants in each tray and then repeat the process after 30 minutes

### Step 6. 24hrs after feeding/once trays have run dry

- Switch Reservoir on to restore supply of water.
- Repeat process every 5-7 days as required

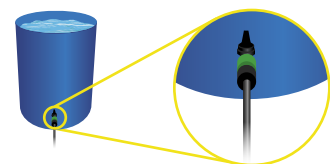

## PREPARATION

CocoMats are an excellent means of irrigating and feeding young plants during propagation. Made of coco fibre and natural latex, the CocoMat controls watering by holding and gradually wicking the water to the plants via capillary action. CocoMats can be cut to fit any size of garden tray. Prepare your CocoMat, place into your tray, followed by a root control sheet and sit small pots, seed trays, plugs, cubes, or root balls on top.

To prepare your CocoMat place it in pH 4.5 water and keep fully submerged to soak for 24-48hrs. During this 24-48hrs the pH of the water may fluctuate as the CocoMat stabilises. There is no need to compensate for fluctuation in the pH levels. A root control sheet will be required on top of the CocoMat. To prepare, submerge the root control sheet in water for 30mins. This is merely in order to wet the sheet. It is not necessary to check the water pH during this soak.

## SET UP - USING EASY2PROPAGATE WITHOUT AQUAVALVE

Growers can use CocoMat in easy2Propagate with or without AQUAvalve. If not using AQUAvalve simply place the prepared CocoMat in the easy2Propagate tray. Place the prepared root control sheet on top of the CocoMat – copper face up.

Place small pots or seed trays on the surface of the root control sheet. Ensure pots/seed trays are flat based and that they allow the growing media to make contact with the surface of the root control sheet. If using plugs, cubes or root balls ensure that they are in full contact with the root control sheet.

Water through each pot, seed tray, seed cell, cube, plug, or root ball once from the top. This helps ensure capillary action starts between the surface of the root control sheet and the growing media on the root control sheet. Pour water into the tray until the CocoMat is 2/3 submerged. Quarter strength nutrient solution may be added if required.

To ensure that your plants receive full levels of light remove protective film from easy2Propagate Lid. Place easy2Propagate Lid onto tray ensuring all corners are fitted snugly.

## SET UP - USING EASY2PROPAGATE WITH AQUAVALVE

Cut a section out of one corner of the CocoMat using heavy duty scissors, this is to allow a space for the AQUAvalve and AQUAvalve cover to sit on the garden tray. Allow sufficient space for both to fit comfortably - 20cm x 12cm is ideal. Cutting is easier after the CocoMat has been soaked. Cut an identically sized, identically placed section out of the root control sheet to allow placement of the AQUAvalve and AQUAvalve cover. Place the CocoMat in the easy2Propagate tray. Place the root control sheet on top of the CocoMat copper face up.

Now place small pots or seed trays on the surface of the root control sheet. Ensure that pots / seed trays are flat based and that they allow the growing media to make contact with the surface of the root control sheet. Similarly, always ensure that plugs, cubes or root balls are in full contact with the root control sheet.

Water through each pot, seed cell, cube, plug, or root ball once from the top. This will help ensure that capillary action starts between the surface of the root control sheet and the growing media in contact with the root control sheet.

## SET UP - THE AQUAVALVE

**1**



Remove threaded collar from AQUAvalve.

Push one end of the ready-assembled 9mm Elbow Bar through the collar and attach to AQUAvalve nozzle.

Then replace the AQUAvalve collar.

**2**



Place the AQUAvalve cover over the AQUAvalve.

The AQUAvalve and cover should be placed directly onto the tray.

Ensure the circular spirit level indicates the tray is level, adjust if required.

**3**



Cut 9mm pipe to appropriate length if required. Connect to 9mm Elbow Bar.

**4**



Position the 9mm Elbow Bar so that it routes out of the piping port in the easy2Propagate lid.

Ensure:

- The pipe does not trap
- The lid fits snugly
- AQUAvalve and Cover still sit flat on the tray.

**5**



Connect to your system using 16mm or 9mm fittings.

**6**



To connect the FlexiTank push 16mm-9mm Click Fit Adapter and Filter onto the 9mm pipe.

Then push the Click-Fit Adapter and Filter onto the FlexiTank tap.

## OPERATION

There are four vents in the easy2Propagate lid. Initially these should be kept shut to maintain warmth and humidity levels. Later the vents can gradually be opened as small seedlings/cuttings establish a root system and need "hardening off". See illustration below for further details.

### Close vents to generate temperature and humidity

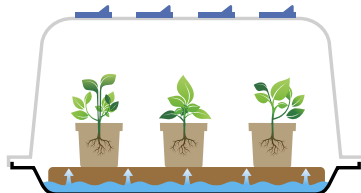

If your area is not sufficiently warm use heat pads under the tray or propagation lights above it to warm the water and create humidity.

### When to begin opening the vents

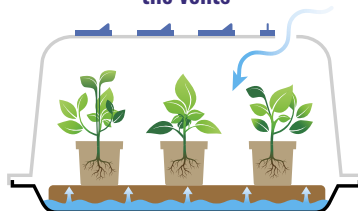

Once the seedlings or cuttings have rooted you can begin to gradually open the vents.

### Hardening off

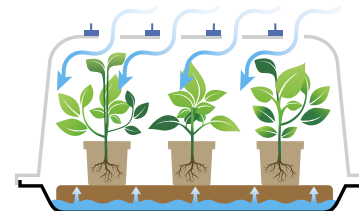

Once the vents are fully opened leave for several days prior to removing the lid.

SEE PAGES 42-43 FOR EASY2PROPAGATE - SEE PAGE 41 FOR MODULE PROPAGATION LIDS  
SEE PAGE 41 FOR 4POT PRO - A COMPLETE SYSTEM INCLUDING PROPAGATION LIDS

## ADVICE

**Nutrients** - Suitable mineral fertilisers, whether liquid or powdered, can be used if required. Do not attempt to use organic fertilisers when using CocoMats. The CocoMats are designed to deliver nutrients at exactly the gradual rate required by plants at this stage of development. This gradual rate of nutrient uptake is far slower than the rate at which organic nutrients decompose. Organic nutrients will simply fall apart before they reach the plants.

Remember that young plants need less food than established ones. Do not connect your easy2Propagate to an AutoPot growing system that is also feeding established plants.

**Water** - All water supplied to the propagator, whether enriched with nutrients or not, should have a pH of 5.5-5.6. This pH level best compliments the composition of the CocoMat. The desirable EC/ppm of the water being supplied will be dependant on the stage of the young plants growth and the substrate used.

**Substrates & Pots** - Plants or seedlings in pots, seed trays, plugs or cubes can be propagated on CocoMats in an easy2Propagate. If pots or seed trays are chosen they may contain a wide range of substrates or blends - rockwool, soil, coco, perlite, and vermiculite represent just a few examples. If a potted substrate or blend is selected it must contain some ingredient that supports capillary action.

If using raised terracotta or bonsai pots, a small length of capillary matting (not included) can be cut and pushed inside the hole at the bottom of the raised pot. The capillary matting will act as a wick.

Orchids will thrive when using the easy2Propagate but will need to be in net pots or similar, please note that suitable water, such as rain water will need to be used if irrigating Orchids along with a suitable liquid mineral feed.

**Temperature** - During germination/rooting of cuttings we recommend a target temperature of 70-80°F / 25-30°C with minimum 80% humidity. Once rooted reduce temperature and humidity by 10/15%.

A suitable heat mat can be used under the easy2Propagate tray to help maintain warmth to delicate young plants, if required.

**Connection** - Multiple easy2Propagate units can be simultaneously fed from a single reservoir. Each propagator can be added as an extension from the main feeding line in a matter of minutes. easy2Propagate incorporates AutoPot AQUAvalve technology so each propagator functions entirely independently of the others, there is no recirculation of water or nutrients, no plumbing is required for waste as the units utilise every drop. Growth in each propagator can commence or cease without impacting other propagators in the system.

Such propagation systems are often created with the use of Danish trolleys and a header reservoir/tank. The Danish trolleys can be used to incorporate lights and/or heat mats and will help maximise growing space. If Danish trolleys are not an option then multiple propagators may still function in a system. Whatever the arrangement, ensure the reservoir is positioned above the highest propagator.

After plants have been potted up and have grown larger the easy2Propagate can continue to be utilised without the dome in order to provide ultra-low maintenance feeding.

## TYPES OF RESERVOIR

- AutoPot Watering Systems are supplied with reservoirs specifically selected on the basis of their capacity to serve the number of pots in that system.
- Should you wish to use an alternative reservoir it is simple to do so thanks to our range of click-fit adapters and filters but it is important to ensure you have sufficient capacity.
- AutoPot offer three types of reservoir; Rigid Plastic Reservoirs, FlexiTanks and FlexiTank Pro. Rigid Plastic Reservoirs are supplied with smaller systems. FlexiTanks come as standard with any system of six pots or more (1Pot XL/XL FlexiPot) and with any system of eight pots or more (1Pot/easy2grow). FlexiTank Pro is an optional upgrade / separate.
- The guidance below applies to all three types of AutoPot reservoirs. It also applies as a general guide to use of non-AutoPot reservoirs where combined with AutoPot Watering Systems, although we cannot take responsibility for any issues arising from the use of non-AutoPot reservoirs or the use of guidance below in relation to non-AutoPot reservoirs.

## SET UP

- Get your reservoir correctly positioned before filling. Never attempt to drag or otherwise reposition a reservoir when in use, regardless of the fill level.
- Gravity pressure is necessary in order for the system to function therefore always raise your reservoir to a minimum of 150mm above the highest AQUAvalve.
- Always use a filter with your reservoir, check filters once a week and clean if necessary - especially if using organics / if in a poor water area.
- Do not place an air stone in the reservoir as this can raise pH levels of the nutrient solution. A water pump may be used to agitate the solution but is not necessary.

## OPERATION

- Gravity pressure is necessary in order for the system to function - therefore always raise your tank to a minimum of 150mm above the highest AQUAvalve.
- AQUAvalve5 has revolutionised the way in which organics can be fed through AutoPot Watering Systems. For the first time, we can recommend almost constant feeding of liquid organic nutrients, additives, and boosters in solution via the reservoir and pipework. It should be noted that this applies only to systems equipped with AQUAvalve5 and 9mm pipe and fittings. Earlier model AQUAvalves with 6mm pipe and fittings cannot feed liquid organics in solution via the reservoir and pipework on a constant basis. The wider apertures of fittings and pipework on AQUAvalve5 equipped systems produce vastly increased flow rates that practically eliminate potential blockages.
- Re-fill the reservoir when there is approximately a 1/3 of the solution left - NEVER ALLOW THE RESERVOIR TO RUN EMPTY.
- When refilling the reservoir turn the tap off. Refill then leave for 30-60 minutes. Then turn the tap back on. This procedure prevents any sediment being pulled through the pipes whilst refilling.
- Use your reservoir to flush your pots at the end of your growing season. Simply supply pH stable plain water from the reservoir to the modules for the last 10-14 days. DO NOT pour water through the top of the pots. Salt build up occurs in the top 1"/2.5cm of the substrate, where it has no detrimental effect on the plants growth. Pouring water through the pot at the flushing stage may damage roots due to the toxicity of the salt build up at the top of the substrate.

## WATER & TEMPERATURE

- Generally the reservoir is best positioned outside the growing area. Aim for a water temperature of between 18 and 21°C in the reservoir
- Aim for a reservoir pH of 5.8 if growing with soil or 5.5-5.6 if with coco. When using AutoPot, ultimately the most important pH level is that found in the module tray with 6-6.5 being the ideal range and 6.3 being perfect. Fine-tune your reservoir pH to achieve this.
- Always use a filter with your reservoir, check filters once a week and clean if necessary - especially if using organics / if in a poor water area.
- If you are in a hard water area it may be necessary to flush your pipework more than once a week. Hard water reacts more with nutrients creating sediments that can build up.
- We always recommend the use of Water Monitoring devices. Such devices allow you to monitor temperature, pH, and conductivity. They help you read the warning signs before your plants are affected by fluctuations, they can illuminate the causes of changes in growth and, ultimately, they can ensure you get the most from your plants.
- If your water temperatures exceed 21°C / 70° F oxygen content in the water starts to rapidly decrease. This may have an adverse effect on plant health.
- If using organics, additives, or boosters clean the reservoir every time it is almost empty. To do this, disconnect, empty and discard any remaining nutrient, clean the tank out, and refill with pH stable plain water. Reconnect and run with this pH stable plain water for 12/24hrs before adding feed again.

### ALL AUTOPOT MODULES & WATERING SYSTEMS

- The entire AutoPot range is now supplied as standard with the improved, large-bore AQUAvalve5 and with 9mm, 9-16mm, and 16mm pipework and fittings.
- The original AQUAvalve, the 6mm pipework and 6mm fittings previously supplied with AutoPot Watering Systems are still available as spares, as are 16mm-6mm fittings.
- Pre-2020 1Pot, XL, XL FlexiPot, and easy2grow trays, pots and lids will accommodate the new AQUAvalve5, the 9mm fittings and 9mm pipe.
- Newly sold Tray Systems, AQUAbox Straight, AQUAbox Spyder, and 47L/30L Tanks are drilled out to accept 9mm pipe and fittings. Pre-2020 Tray System, AQUAbox Straight, and AQUAbox Spyder will fit AQUAvalve5 but will need existing holes drilling out to 12mm ø. Use a 9mm Grommet and 9mm Golf Filter to run 9mm pipe required for AQUAvalve5.
- Pre-2020 47L/30L Tanks need existing holes drilling out to 12mm ø. Use a 9mm Grommet and 9mm Golf Filter to run 9mm pipe required for AQUAvalve5.
- FlexiTank and FlexiTank Pro Couplers are unchanged. Only in the event of connecting directly to 9mm pipe do they require the new 16mm-9mm Filter and Adapter.



#### FILTERS

- Always use a filter with your reservoir, check filters once a week and clean if necessary - especially if using organics / if in a poor water area.
- Wash filter material in mild soap and lukewarm water or in dilute hydrogen peroxide
- Once disassembled the filter bodies can be washed in mild soap and lukewarm water, in dilute hydrogen peroxide, or in a dishwasher
- Depending on the condition of your filter replace every 5 yrs. Golf Filters feature a replaceable material available separately from AutoPot.



#### AQUAVALVE

##### Ensuring that the AQUAvalve floods and drains correctly

- Ensure the two silicones are in place. Hold the AQUAvalve at eye level so that you can see the silicone fitted to the top float resting on the hole below it. The silicone must create a tight seal when touching the hole. If it looks like it is not sitting parallel on the hole below, simply lift the top float and apply pressure to one side of the silicone, drop the float and hold at eye level again. Repeat the procedure if necessary.
- Ensure the AQUAvalve is secured to the tray. If using AutoPot trays position the half-moon on the bottom of the AQUAvalve over the T-section in the tray, push down firmly on the main body only. If using in a garden tray place an AQUAvalve Cover over the AQUAvalve.

##### Cleaning

- AQUAvalve is easily disassembled. Held vertically the top float will slide all the way across. The bottom float unclips from its pivot position.
- Ensure that silicones are removed from the AQUAvalve before cleaning and are only replaced when the AQUAvalve is completely dry.
- AQUAvalves can be scrubbed using a toothbrush or even placed in the dishwasher.
- Blowing through the AQUAvalve nozzle or use of a pipe cleaner or paperclip will help remove any build up that has occurred.
- When disassembling the system dip the still-connected AQUAvalve and pipe in hot water to ease separation. Once loosened remove the pipework by pulling it directly away from the nozzle. Avoid twisting/wiggling the end of the pipe away from the nozzle.
- Do not under any circumstances use a drill to clear the AQUAvalve nozzle. This will potentially damage the AQUAvalve beyond repair.



#### FITTINGS

- Utilise the flush taps at the ends of the pipework to help keep the system clean and free of sediment. To do so open each tap into a bucket or similar for 30 secs-1 min. Do this once a week if using mineral nutrient. Ideally undertake once you have re-filled your reservoir and allowed it to settle for an hour. A full reservoir provides you with the maximum pressure to flush.
- AutoPot only supply and only recommend official AutoPot-branded fittings for use with AutoPot Watering Systems.



#### PIPEWORK

- Dip the end of your pipe in **hot water** before connecting to fittings. This will soften the pipe and allow you to connect fittings with ease.
- Dip the end of your pipe in **cold water** before passing through grommets. This will harden the pipe, aiding insertion.
- When disassembling the system dip still-connected fittings and pipework in hot water to ease separation.
- If using mineral additives or organics in a larger system you may wish to use a line cleaner such as D-Block, Drip Clean or Keep It Clean. With regular plain water flushing this should not be absolutely necessary but remains an option if desired.



#### FLEXIPOTS

- FlexiPots are incredibly durable and can be reused repeatedly. They can also be washed if desired.
- Powdery green or white discolouration can occur on the outside of the pot but is entirely natural. It is merely salt or mineral build up.
- Empty after using and let the pot dry. After a few days remaining debris will easily brush off. At this point the pot is ready for reuse.
- If desired, growers can then also wash the bags in peroxide to sterilize - either in a washing machine or dipped in a tub.
- Allow to dry naturally. Do not put FlexiPots in a tumble dryer.



#### PLASTIC POTS

- Always clean the side and bottom of each pot before you place in the tray, this will remove any soil particles and ensure your system is clean. In turn ensuring your AQUAvalve is kept clean and free of growing media - especially if growing with Perlite.
- The 15L pots used in the 1Pot module and the 8.5L pots used in the easy2grow module are interchangeable and can be used in either tray.
- Don't place trays on cold concrete floors, water in the tray will be chilled from below and will effect plant growth. Consider placing polystyrene, cardboard under each tray to ensure the water temperature in the tray is not affected. Always ensure trays are level.

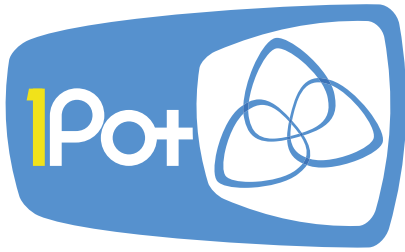

**INCREDIBLE YIELDS FOR HOUSEHOLD GARDENERS AND COMMERCIAL GROWERS**

**FOR ALL STAGES OF ADULT GROWTH - 15 L POT AS STANDARD, ALSO FITS 8.5 L**

**SIMPLE, EFFICIENT, LOW MAINTENANCE FEEDING AND WATERING OF PLANTS**



### **EFFICIENCY**

As with all AutoPot Watering Systems, the 1Pot module operates power-free without wasting a drop of water or fertiliser. The benefits of this efficiency are twofold. Your overheads are decimated at a stroke and, without reliance on utilities, any space becomes a viable proposition for growing.

**E: MAIL@AUTOPOT.CO.UK**

### **VERSATILITY**

The 1Pot Module can be used for a wide range of plant types and sizes. Flowering plants and shrubs thrive and produce an abundance of blooms and foliage. Modules are supplied with 15L pots but the tray also perfectly accommodates our 8.5 L pot, allowing you to alternate between crops with ease.

**🌐 AUTOPOT.CO.UK**

### **LONGEVITY**

If your plants require a large individual footprint, typically achieve greater-than-average height, or grow over a longer period then the 1Pot Module represents an excellent option. AutoPot modules require no plumbing for recirculation or waste water so they can be added or removed from a layout at will.

**📷 @AUTOPOT\_GLOBAL**

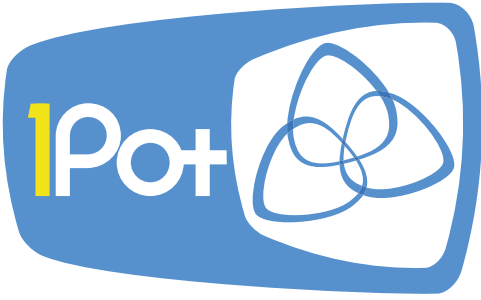

**ALL SYSTEMS COMPLETE WITH PIPEWORK & FITTINGS**

**ASK YOUR STOCKIST FOR FLEXITANK PRO OPTIONS**

**RRP - RECOMMENDED RETAIL PRICE**



**FOR FLOOR SPACE REQUIREMENTS SEE PAGES: 16-17**



**1POT SYSTEM - AP200/SQ/1**

**RRP £45.00**

with 47L reservoir



**2POT SYSTEM - AP200/SQ/2**

**RRP £73.50**

with 47L reservoir



**4POT SYSTEM - 4POT/PACK/1**

**RRP £112.00**

with 47L reservoir



**6POT SYSTEM - AP200/SQ/6**

**RRP £176.00**

with 47L reservoir



**8POT SYSTEM - AP200/SQ/8**

**RRP £255.00**

with 100L FlexiTank



**9POT SYSTEM - AP200/SQ/9**

**RRP £283.50**

with 100L FlexiTank



**12POT SYSTEM - AP200/SQ/12**

**RRP £380.00**

with 225L FlexiTank



**16POT SYSTEM - AP200/SQ/16**

**RRP £470.00**

with 225L FlexiTank



**24POT SYSTEM - AP200/SQ/24**

**RRP £730.00**

with 400L FlexiTank



**36POT SYSTEM - AP200/SQ/36**

**RRP £1,020.00**

with 400L FlexiTank



**48POT SYSTEM - AP200/SQ/48**

**RRP £1,360.00**

with 400L FlexiTank



**60POT SYSTEM - AP200/SQ/60**

**RRP £1,600.00**

with 400L FlexiTank



**80POT SYSTEM - AP200/SQ/80**

**RRP £1,975.00**

with 750L FlexiTank



**100POT SYSTEM - AP200/SQ/100**

**RRP £2,260.00**

with 750L FlexiTank

@AUTOPOTUK

AUTOPOT.CO.UK

@AUTOPOTSYSYSTEMS

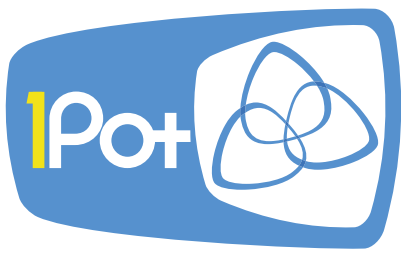

# SYSTEM SPECIFICATIONS

9mm pipe - Outside  $\varnothing$  9mm/Inside  $\varnothing$  7mm    16mm pipe - Outside  $\varnothing$  16mm/Inside  $\varnothing$  13mm

- AQUAvalve5
- 9mm Top Hat (TH) Grommet
- 9mm pipe
- 9mm Inline Tap
- 16mm Click Fit Filter
- 9mm Golf Filter
- 16mm pipe
- 16mm Inline Tap

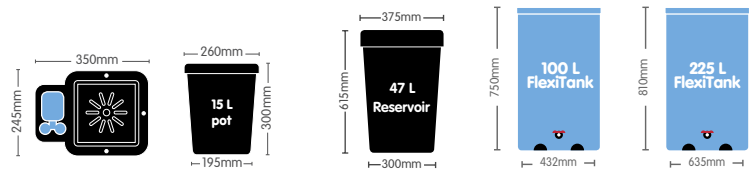

- 16mm Cross Connector
- 16-9mm Cross Connector
- 9mm Cross Connector
- 16mm Tee Connector
- 16-9mm Tee Connector
- 9mm Tee Connector

## 1POT SYSTEM - AP200/SQ/1

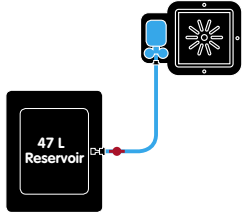

CONTENTS	
1x 47 L reservoir & lid	1x 9mm inline tap
2x 9mm TH grommet	1x AQUAvalve5
1x 9mm golf filter	1.5 m of 9mm pipe
1x 1Pot tray & lid	1x root control disc
1x 15 L pot	1x marix disc
	1x instruction sheet

**FLOORSPACE REQUIREMENTS: 0.8M x 0.8M EX. RES.**

## 2POT SYSTEM - AP200/SQ/2

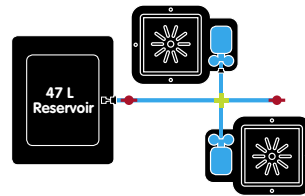

CONTENTS	
1x 47 L reservoir & lid	1x 9mm cross connector
3x 9mm TH grommet	2x 9mm inline tap
1x 9mm golf filter	2x AQUAvalve5
2x 1Pot tray & lid	2 m of 9mm pipe
2x 15 L pot	2x root control disc
	2x marix disc
	1x instruction sheet

**FLOORSPACE REQUIREMENTS: 1M x 1M EX. RES.**

## 4POT SYSTEM - 4POT/PACK/1

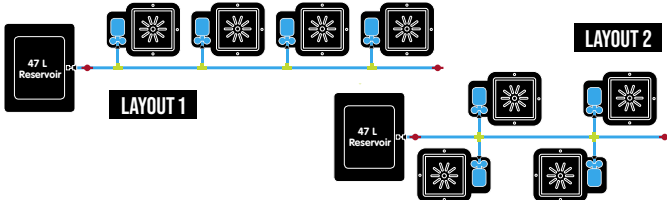

CONTENTS		FLOORSPACE REQUIREMENTS: 1.2M x 1.2M EX. RES.	
1x 47 L reservoir & lid	1x 9mm golf filter	4x AQUAvalve5	4 m of 9mm pipe
4x 1Pot tray & lid	4x 15 L pot	2x 9mm cross connector	4x root control disc
5x 9mm TH grommet	2x 9mm inline tap	4x 9mm tee connector	4x marix disc

## 6POT SYSTEM - AP200/SQ/6

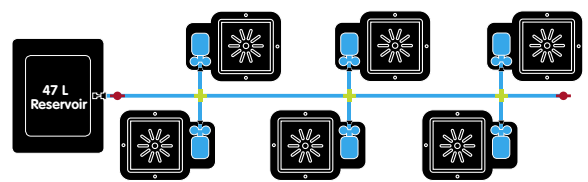

CONTENTS		FLOORSPACE REQUIREMENTS: 2M x 1M EX. RES.	
1x 47 L reservoir & lid	1x 9mm golf filter	6x AQUAvalve5	6x root control disc
6x 1Pot tray & lid	6x 15 L pot	3x 9mm cross connector	6x marix disc
7x 9mm TH grommet	2x 9mm inline tap	6 m of 9mm pipe	1x instruction sheet

## 8POT SYSTEM - AP200/SQ/8

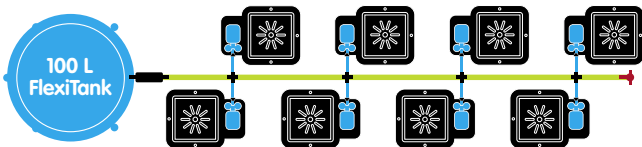

CONTENTS		FLOORSPACE REQUIREMENTS: 3M x 1M EX. RES.	
1x 100 L FlexiTank	8x 9mm TH grommet	8x AQUAvalve5	4 m of 16mm pipe
8x 1Pot tray & lid	8x 15 L pot	4x 16-9mm cross connector	8x root control disc
1x 16mm click-fit filter	1x 16mm inline tap	4 m of 9mm pipe	1x instructions

## 9POT SYSTEM - AP200/SQ/9

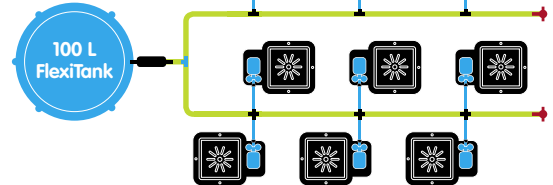

CONTENTS		FLOORSPACE REQUIREMENTS: 2M x 2M EX. RES.		
1x 100 L FlexiTank	9x 9mm TH grommet	9x AQUAvalve5	4.5 m of 9mm pipe	1x 16mm tee
9x 1Pot tray & lid	9x 15 L pot	3x 16-9mm cross connector	6 m of 16mm pipe	9x marix disc
1x 16mm click-fit filter	2x 16mm inline tap	3x 16-9mm tee connector	9x root control disc	1x instructions

## 12POT SYSTEM - AP200/SQ/12

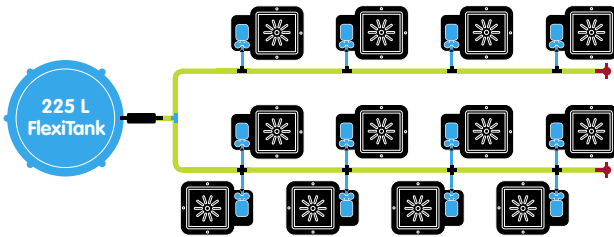

CONTENTS		FLOORSPACE REQUIREMENTS: 2M x 2M EX. RES.		
1x 225 L FlexiTank	12x 9mm TH grommet	12x AQUAvalve5	6 m of 9mm pipe	1x 16mm tee
12x 1Pot tray & lid	12x 15 L pot	4x 16-9mm cross connector	8 m of 16mm pipe	12x marix disc
1x 16mm click-fit filter	2x 16mm inline tap	4x 16-9mm tee connector	12x root control disc	1x instructions

## 16POT SYSTEM - AP200/SQ/16

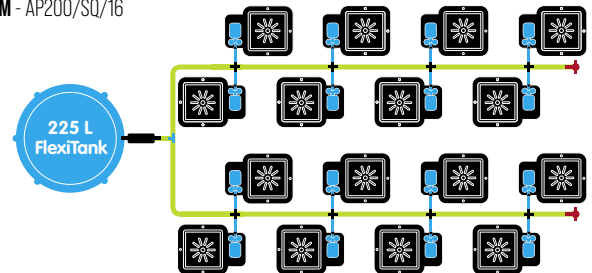

CONTENTS		FLOORSPACE REQUIREMENTS: 2.5M x 2.5M EX. RES.			
1x 225 L FlexiTank	16x 9mm TH grommet	16x AQUAvalve5	8 m of 9mm pipe	16x marix disc	
16x 1Pot tray & lid	16x 15 L pot	1x 16mm tee connector	8 m of 16mm pipe	1x instruction sheet	
1x 16mm click-fit filter	2x 16mm inline tap	8x 16-9mm cross connector	16x root control disc		



24POT SYSTEM - AP200/SQ/24

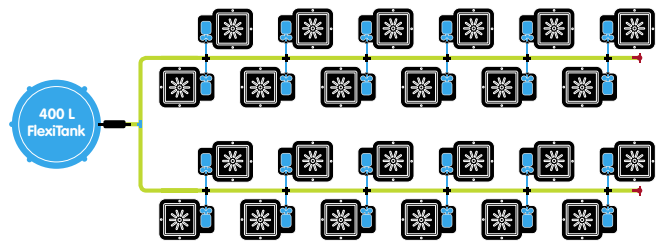

CONTENTS

- |                          |                            |                       |
|--------------------------|----------------------------|-----------------------|
| 1x 400 L FlexiTank       | 24x 9mm TH grommet         | 24x AQUAvalve5        |
| 24x 1Pot tray & lid      | 1x 16mm tee connector      | 24x root control disc |
| 1x 16mm click-fit filter | 12x 16-9mm cross connector | 24x marix disc        |
| 2x 16mm inline tap       | 24x 15 L pot               | 12 m of 9mm pipe      |
|                          |                            | 10 m of 16mm pipe     |
|                          |                            | 1x instruction sheet  |

FLOORSPACE REQUIREMENTS: 2M x 3M EX. RES.

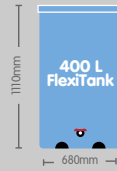

36POT SYSTEM - AP200/SQ/36

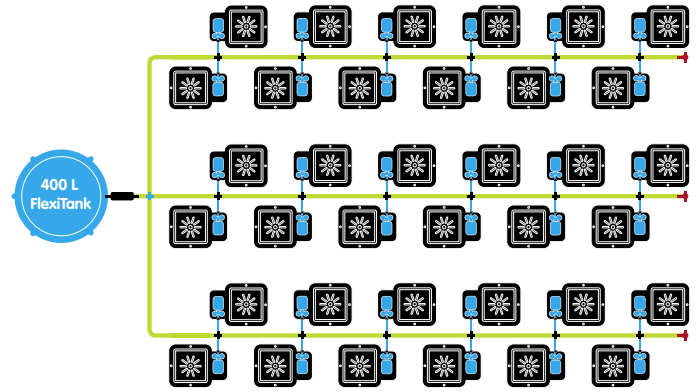

CONTENTS

- |                          |                            |                       |
|--------------------------|----------------------------|-----------------------|
| 1x 400 L FlexiTank       | 36x 9mm TH grommet         | 36x AQUAvalve5        |
| 36x 1Pot tray & lid      | 1x 16mm cross connector    | 36x root control disc |
| 1x 16mm click-fit filter | 18x 16-9mm cross connector | 36x marix disc        |
| 3x 16mm inline tap       | 36x 15 L pot               | 18 m of 9mm pipe      |
|                          |                            | 15 m of 16mm pipe     |
|                          |                            | 1x instruction sheet  |

FLOORSPACE REQUIREMENTS: 3.5M x 3.5M EX. RES.

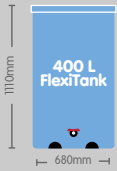

48POT SYSTEM - AP200/SQ/48

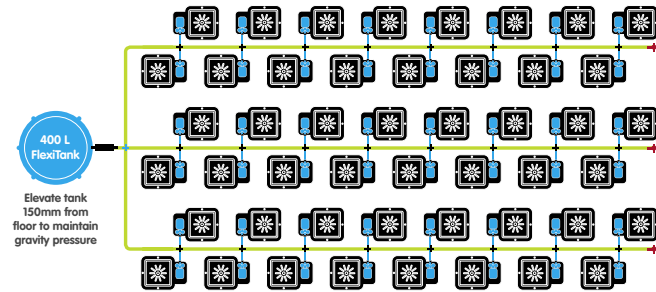

CONTENTS

- |                          |                            |                       |
|--------------------------|----------------------------|-----------------------|
| 1x 400 L FlexiTank       | 48x 9mm TH grommet         | 48x AQUAvalve5        |
| 48x 1Pot tray & lid      | 1x 16mm cross connector    | 48x root control disc |
| 1x 16mm click-fit filter | 24x 16-9mm cross connector | 48x marix disc        |
| 3x 16mm inline tap       | 48x 15 L pot               | 24 m of 9mm pipe      |
|                          |                            | 20 m of 16mm pipe     |
|                          |                            | 1x instruction sheet  |

FLOORSPACE REQUIREMENTS: 4M x 4M EX. RES.



60POT SYSTEM - AP200/SQ/60

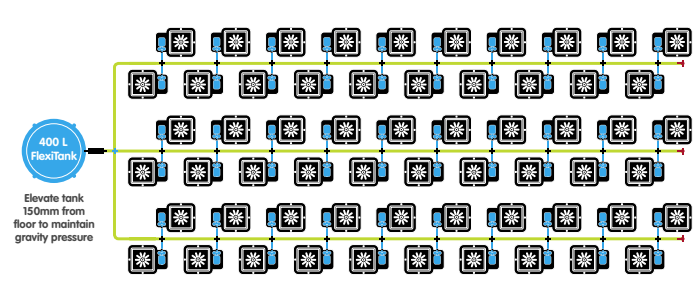

CONTENTS

- |                          |                            |                       |
|--------------------------|----------------------------|-----------------------|
| 1x 400 L FlexiTank       | 60x 9mm TH grommet         | 60x AQUAvalve5        |
| 60x 1Pot tray & lid      | 1x 16mm cross connector    | 60x root control disc |
| 1x 16mm click-fit filter | 30x 16-9mm cross connector | 60x marix disc        |
| 3x 16mm inline tap       | 60x 15 L pot               | 30 m of 9mm pipe      |
|                          |                            | 25 m of 16mm pipe     |
|                          |                            | 1x instruction sheet  |

FLOORSPACE REQUIREMENTS: 5.5M x 3.5M EX. RES.



80POT SYSTEM - AP200/SQ/80

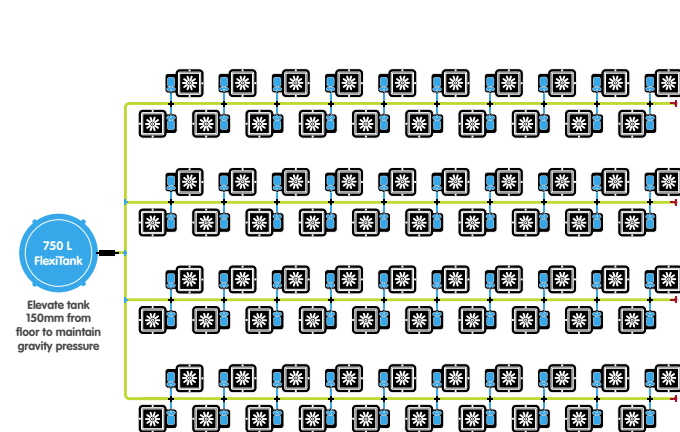

CONTENTS

- |                          |                            |                      |
|--------------------------|----------------------------|----------------------|
| 1x 750 L FlexiTank       | 80x 9mm TH grommet         | 80x marix disc       |
| 80x 1Pot tray & lid      | 40x 16-9mm cross connector | 40 m of 9mm pipe     |
| 1x 16mm click-fit filter | 80x 15 L pot               | 30 m of 16mm pipe    |
| 4x 16mm inline tap       | 80x AQUAvalve5             |                      |
| 3x 16mm tee connector    | 80x root control disc      | 1x instruction sheet |

FLOORSPACE REQUIREMENTS: 6M x 5M EX. RES.



100POT SYSTEM - AP200/SQ/100

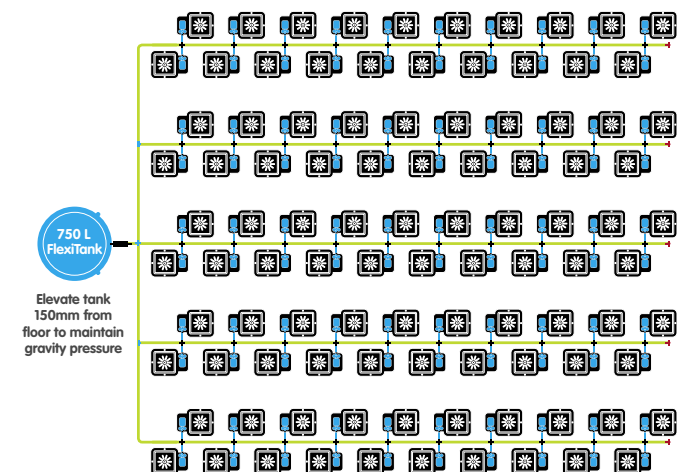

CONTENTS

- |                          |                            |                        |
|--------------------------|----------------------------|------------------------|
| 1x 750 L FlexiTank       | 100x 9mm TH grommet        | 100x marix disc        |
| 100x 1Pot tray & lid     | 1x 16mm cross connector    | 100x root control disc |
| 1x 16mm click-fit filter | 50x 16-9mm cross connector | 50 m of 9mm pipe       |
| 5x 16mm inline tap       | 100x 15 L pot              | 40 m of 16mm pipe      |
| 2x 16mm tee connector    | 100x AQUAvalve5            | 1x instruction sheet   |

FLOORSPACE REQUIREMENTS: 6M x 5.5M EX. RES.





**IDEAL FOR SHORT, BUSHY VARIETIES OR TALL-GROWING VINE PLANTS**

**PERFECT FOR LARGER PLANTS DURING INITIAL STAGES OF ADULT GROWTH**

**AVAILABLE WITH 8.5 L OR 15 L POTS - ALTERNATE YOUR CROPS AT WILL**



## MAXIMUM OUTPUT

easy2grow's phenomenally space-efficient two-pot module has been helping growers get the absolute maximum out of their available spaces for years. The systems are ideally suited to either short, bushy varieties like herbs or strawberries, or tall growing vine plants.

## EARLY STAGES

With larger plants the systems can provide a perfect solution for initial stages of adult growth. The pots provide ample space in which young plants can thrive whilst AutoPot AQUAvalve technology ensures they are fed and watered exactly as and when required

## SCALABILITY

easy2grow is supplied with 8.5 L pots as standard but is also available with 15 L pots. A potentially infinite number of modules can be added to a system as and when required. These qualities make easy2grow ideal for alternating crops and for phased expansion.

**E: MAIL@AUTOPOT.CO.UK**

**🌐 AUTOPOT.CO.UK**

**📷 @AUTOPOT\_GLOBAL**



**ALL SYSTEMS COMPLETE WITH PIPEWORK & FITTINGS**

**ASK YOUR STOCKIST FOR FLEXITANK PRO OPTIONS**

**RRP - RECOMMENDED RETAIL PRICE**



**FOR FLOOR SPACE REQUIREMENTS SEE PAGES: 20-21**



with 47L reservoir

**EASY2GROW KIT - AP201/SQ RRP £54.00**

**WITH 15L POTS - AP202/SQ RRP £56.40**



with 47L reservoir

**EASY2GROW 4 - AP201/SQ/4 RRP £77.50**

**WITH 15L POTS - AP202/SQ/4 RRP £82.50**



with 47L reservoir

**EASY2GROW 6 - AP201/SQ/6 RRP £102.00**

**WITH 15L POTS - AP202/SQ/6 RRP £108.50**



with 100L FlexiTank

**EASY2GROW 12 - AP201/SQ/12 RRP £225.00**

**WITH 15L POTS - AP202/SQ/12 RRP £240.00**



with 225L FlexiTank

**EASY2GROW 16 - AP201/SQ/16 RRP £295.00**

**WITH 15L POTS - AP202/SQ/16 RRP £315.00**



with 225L FlexiTank

**EASY2GROW 20 - AP201/SQ/20 RRP £350.00**

**WITH 15L POTS - AP202/SQ/20 RRP £375.00**



with 225L FlexiTank

**EASY2GROW 24 - AP204/SQ/24 RRP £410.00**

**WITH 15L POTS - AP202/SQ/24 RRP £435.00**



with 400L FlexiTank

**EASY2GROW 40 - AP201/SQ/40 RRP £675.00**

**WITH 15L POTS - AP202/SQ/40 RRP £720.00**



with 400L FlexiTank

**EASY2GROW 48 - AP201/SQ/48 RRP £780.00**

**WITH 15L POTS - AP202/SQ/48 RRP £835.00**

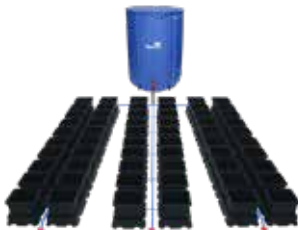

with 400L FlexiTank

**EASY2GROW 60 - AP201/SQ/60 RRP £930.00**

**WITH 15L POTS - AP202/SQ/60 RRP £1,000.00**

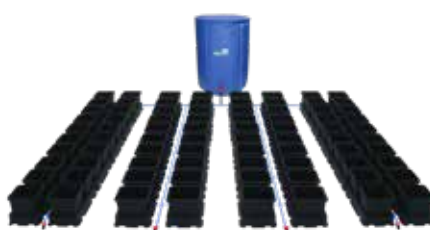

with 750L FlexiTank

**EASY2GROW 80 - AP201/SQ/80 RRP £1,245.00**

**WITH 15L POTS - AP202/SQ/80 RRP £1,340.00**



with 750L FlexiTank

**EASY2GROW 100 - AP201/SQ/100 RRP £1,530.00**

**WITH 15L POTS - AP202/SQ/100 RRP £1,645.00**

@AUTOPOTUK

AUTOPOT.CO.UK

@AUTOPOTSYSYSTEMS



# SYSTEM SPECIFICATIONS

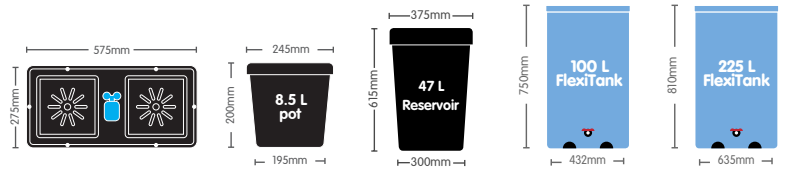

- 9mm pipe - Outside  $\varnothing$  9mm/Inside  $\varnothing$  7mm    16mm pipe - Outside  $\varnothing$  16mm/Inside  $\varnothing$  13mm
- AQUAvalve
  - 9mm Top Hat (TH) Grommet
  - 9mm pipe
  - 9mm Inline Tap
  - 16mm Click Fit Filter
  - 9mm Golf Filter
  - 16mm pipe
  - 16mm Inline Tap

- 16mm Cross Connector
- 16-9mm Cross Connector
- 9mm Cross Connector
- 16mm Tee Connector
- 16-9mm Tee Connector
- 9mm Tee Connector

## EASY2GROW KIT - AP201/SQ or 15L\* AP202/SQ

CONTENTS	
1x 47 L reservoir & lid	1x 9mm inline tap
1x 9mm TH grommet	1x AQUAvalve5
1x 9mm golf filter	1.5 m of 9mm pipe
1x 2Pot tray & lid	2x marix disc
2x 8.5 L pot / *15 L pot	2x PotSock Square
	1x instruction sheet

**FLOORSPACE REQUIREMENTS: 0.8M x 0.8M EX. RES.**

## EASY2GROW 4 - AP201/SQ/4 or 15L\* AP202/SQ/4

CONTENTS	
1x 47 L reservoir & lid	2x 9mm inline tap
1x 9mm TH grommet	2x 9mm tee connector
1x 9mm golf filter	2x AQUAvalve5
2x 2Pot tray & lid	3 m of 9mm pipe
4x 8.5 L pot / *15 L pot	4x marix disc
	4x PotSock Square

**FLOORSPACE REQUIREMENTS: 1M x 1M EX. RES.**

## EASY2GROW 6 - AP201/SQ/6 or 15L\* AP202/SQ/6

CONTENTS			
1x 47 L reservoir & lid	1x 9mm golf filter	3x AQUAvalve5	6x PotSock Square
3x 2Pot tray & lid	6x 8.5 L pot / *15 L pot	3x 9mm tee connector	6x marix disc
1x 9mm TH grommet	2x 9mm inline tap	4 m of 9mm pipe	1x instruction sheet

**FLOORSPACE REQUIREMENTS: 1.2M x 1.2M EX. RES.**

## EASY2GROW 12 - AP201/SQ/12 or 15L\* AP202/SQ/12

CONTENTS			
1x 100 L FlexiTank	12x 8.5 L pot / *15 L pot	3x 16-9mm cross connector	12x PotSock Square
6x 2Pot tray & lid	1x 16mm inline tap	3 m of 9mm pipe	12x marix disc
1x 16mm click-fit filter	6x AQUAvalve5	3 m of 16mm pipe	1x instruction sheet

**FLOORSPACE REQUIREMENTS: 1M x 2M EX. RES.**

## EASY2GROW 16 - AP201/SQ/16 or 15L\* AP202/SQ/16

CONTENTS			
1x 225 L FlexiTank	16x 8.5 L pot / *15 L pot	4x 16-9mm cross connector	16x PotSock Square
8x 2Pot tray & lid	1x 16mm inline tap	4 m of 9mm pipe	16x marix disc
1x 16mm click-fit filter	8x AQUAvalve5	4 m of 16mm pipe	1x instruction sheet

**FLOORSPACE REQUIREMENTS: 2.5M x 1M EX. RES.**

## EASY2GROW 20 - AP201/SQ/20 or 15L\* AP202/SQ/20

CONTENTS			
1x 225 L FlexiTank	20x 8.5 L pot / *15 L pot	5x 16-9mm cross connector	20x PotSock Square
10x 2Pot tray & lid	1x 16mm inline tap	6 m of 9mm pipe	20x marix disc
1x 16mm click-fit filter	10x AQUAvalve5	6 m of 16mm pipe	1x instruction sheet

**FLOORSPACE REQUIREMENTS: 3.5M x 1M EX. RES.**

## EASY2GROW 24 - AP201/SQ/24 or 15L\* AP202/SQ/24

CONTENTS			
1x 225 L FlexiTank	2x 16mm inline tap	6x 16-9mm cross connector	24x PotSock Square
12x 2Pot tray & lid	12x AQUAvalve5	6 m of 9mm pipe	24x marix disc
1x 16mm click-fit filter	1x 16mm tee connector	8 m of 16mm pipe	1x instruction sheet
24x 8.5 L pot / *15 L pot			

**FLOORSPACE REQUIREMENTS: 2.5M x 2M EX. RES.**

## EASY2GROW 40 - AP201/SQ/40 or 15L\* AP202/SQ/40

CONTENTS			
1x 400 L FlexiTank	2x 16mm inline tap	10x 16-9mm cross connector	40x PotSock Square
20x 2Pot tray & lid	20x AQUAvalve5	10 m of 9mm pipe	40x marix disc
1x 16mm click-fit filter	1x 16mm tee connector	10 m of 16mm pipe	1x instruction sheet
40x 8.5 L pot / *15 L pot			

**FLOORSPACE REQUIREMENTS: 2.5M x 3M EX. RES.**

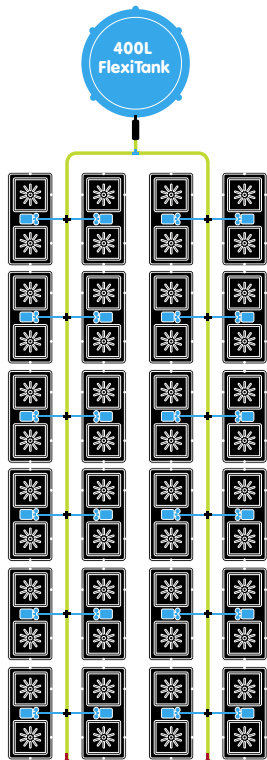

**CONTENTS**

- 1x 400 L FlexiTank
- 24x 2Pot tray & lid
- 1x 16mm click-fit filter
- 48x 8.5 L pot / \*15 L pot
- 2x 16mm inline tap
- 1x 16mm tee connector
- 24x AQUAvalve5
- 12x 16-9mm cross connector
- 12 m of 9mm pipe
- 12 m of 16mm pipe
- 48x marix disc
- 48x PotSock Square
- 1x instruction sheet

**FLOORSPACE REQUIREMENTS:**  
4.5M x 2.5M EX. RES.

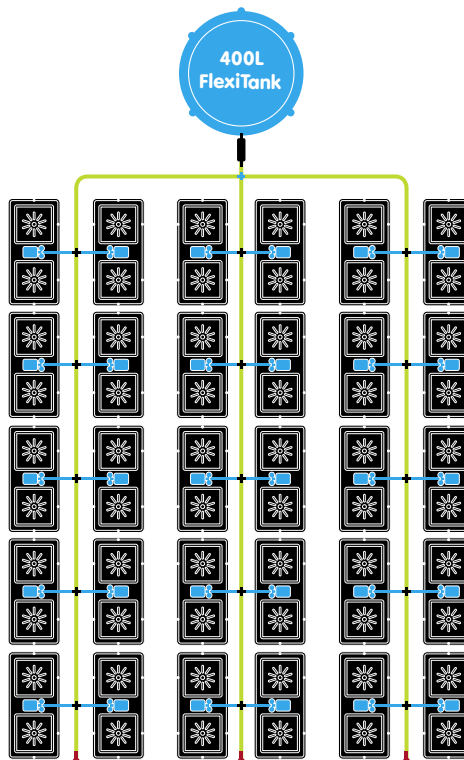

**CONTENTS**

- 1x 400 L FlexiTank
- 30x 2Pot tray & lid
- 1x 16mm click-fit filter
- 60x 8.5 L pot / \*15 L pot
- 3x 16mm inline tap
- 1x 16mm cross connector
- 30x AQUAvalve5
- 15x 16-9mm cross connector
- 15 m of 9mm pipe
- 15 m of 16mm pipe
- 60x marix disc
- 60x PotSock Square
- 1x instruction sheet

**FLOORSPACE REQUIREMENTS:**  
3.5M x 3.5M EX. RES.

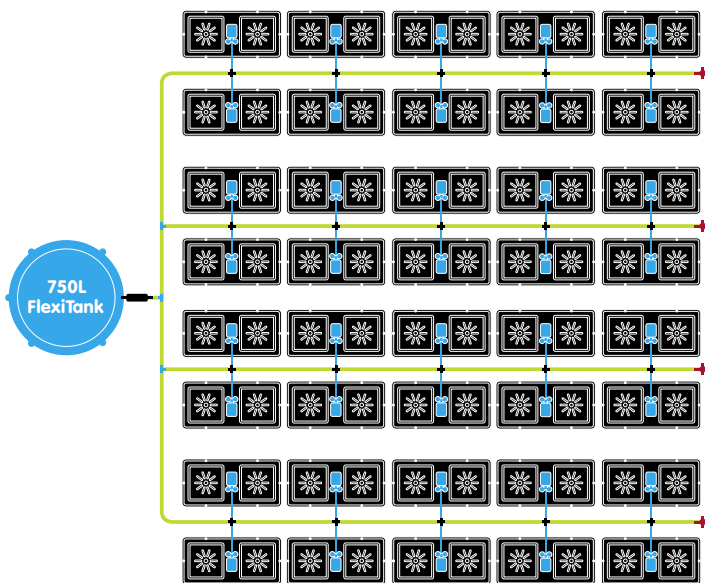

**CONTENTS**

- 1x 750 L FlexiTank
- 40x 2Pot tray & lid
- 1x 16mm click-fit filter
- 80x 8.5 L pot / \*15 L pot
- 4x 16mm inline tap
- 40x AQUAvalve5
- 3x 16mm tee connector
- 20x 16-9mm cross connector
- 20 m of 9mm pipe
- 20 m of 16mm pipe
- 80x PotSock Square
- 80x marix disc
- 1x instruction sheet

**FLOORSPACE REQUIREMENTS:** 4M x 5M EX. RES.

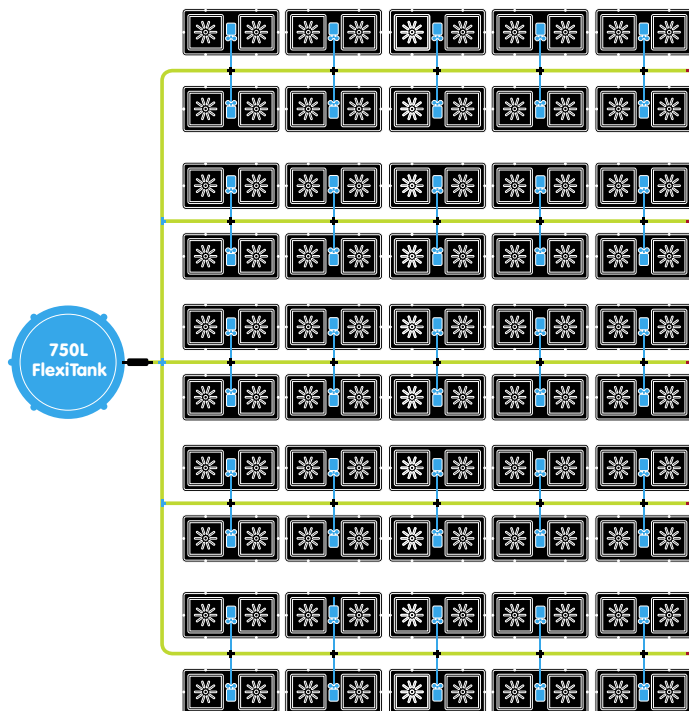

**CONTENTS**

- 1x 750 L FlexiTank
- 50x 2Pot tray & lid
- 1x 16mm click-fit filter
- 100x 8.5 L pot / \*15 L pot
- 5x 16mm inline tap
- 50x AQUAvalve5
- 2x 16mm tee connector
- 1x 16mm cross connector
- 25x 16-9mm cross connector
- 25 m of 9mm pipe
- 25 m of 16mm pipe
- 100x PotSock Square
- 100x marix disc
- 1x instruction sheet

**FLOORSPACE REQUIREMENTS:** 5.5M x 3.5M EX. RES.

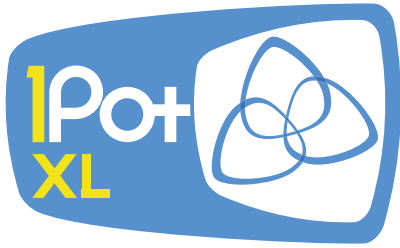

DEVELOPED BY AUTOPOT TO MEET THE DEMANDS OF THE AMBITIOUS GARDENER

FEATURING AN IMMENSE 25 LITRE GROWING CAPACITY

FOR GROWERS LOOKING TO CULTIVATE BIG PLANTS & ACHIEVE EVEN BIGGER YIELDS

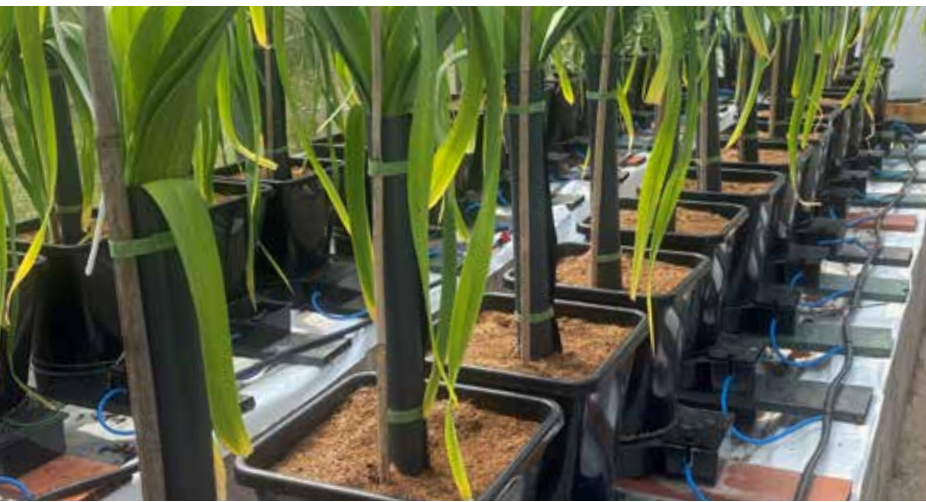

## FLEXIBLE BY DESIGN

The round base and modular design means each 1Pot XL module can be rotated, repositioned or removed without difficulty or detrimental effects on the system.

Such adjustability maximises the efficiency of lighting arrangements at every stage of growth.

## IMMENSE POT SIZE

A 25 L pot means plants grow efficiently, continuously and vigorously.

Plant development in the 1Pot XL module is unhindered by the need to transfer to a larger pot, such is the module's exceptional capacity.

## PLANT HEALTH

Each module is fed by its own AQUAvalve, responding to the plant's needs and ensuring each plant can develop at its own rate - essential for the stock, specimen and mother plants with which commercial and hobby growers populate their greenhouses.

E: MAIL@AUTOPOT.CO.UK

🌐 AUTOPOT.CO.UK

📷 @AUTOPOT\_GLOBAL

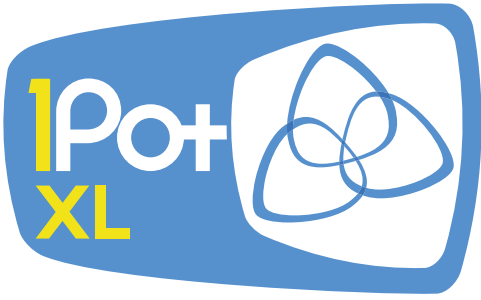

**ALL SYSTEMS COMPLETE WITH PIPEWORK & FITTINGS**

**ASK YOUR STOCKIST FOR FLEXITANK PRO OPTIONS**

**RRP - RECOMMENDED RETAIL PRICE**



**FOR FLOOR SPACE REQUIREMENTS SEE PAGES: 24-25**



**1POT XL SYSTEM - AP300/XL/1**

with 47L reservoir

**RRP £53.00**



**2POT XL SYSTEM - AP300/XL/2**

with 47L reservoir

**RRP £83.50**



**4POT XL SYSTEM - AP300/XL/4**

with 47L reservoir

**RRP £150.00**



**6POT XL SYSTEM - AP300/XL/6**

with 100L FlexiTank

**RRP £240.00**



**8POT XL SYSTEM - AP300/XL/8**

with 100L FlexiTank

**RRP £305.00**



**9POT XL SYSTEM - AP300/XL/9**

with 100L FlexiTank

**RRP £340.00**



**12POT XL SYSTEM - AP300/XL/12**

with 225L FlexiTank

**RRP £455.00**



**16POT XL SYSTEM - AP300/XL/16**

with 225L FlexiTank

**RRP £590.00**



**24POT XL SYSTEM - AP300/XL/24**

with 400L FlexiTank

**RRP £880.00**

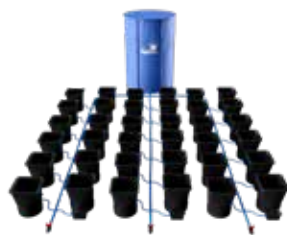

**36POT XL SYSTEM - AP300/XL/36**

with 400L FlexiTank

**RRP £1,220.00**

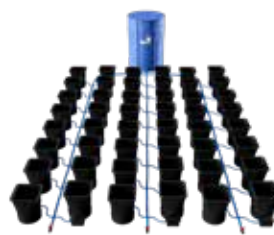

**48POT XL SYSTEM - AP300/XL/48**

with 400L FlexiTank

**RRP £1,560.00**



**60POT XL SYSTEM - AP300/XL/60**

with 400L FlexiTank

**RRP £1,845.00**



**80POT XL SYSTEM - AP300/XL/80**

**RRP £2,380.00**

with 750L FlexiTank

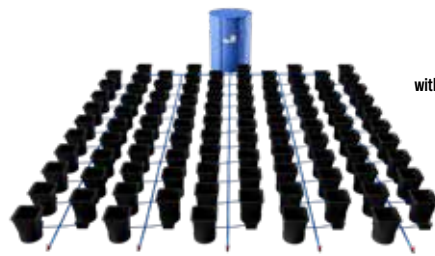

**100POT XL SYSTEM - AP300/XL/100**

**RRP £2,890.00**

with 750L FlexiTank

@AUTOPOTUK

AUTOPOT.CO.UK

@AUTOPOTSYSYSTEMS

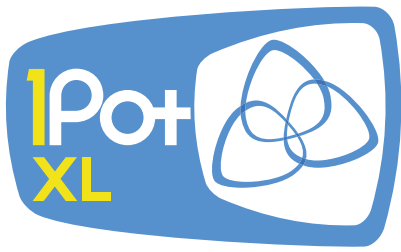

9mm pipe - Outside  $\varnothing$  9mm/Inside  $\varnothing$  7mm    16mm pipe - Outside  $\varnothing$  16mm/Inside  $\varnothing$  13mm

- AQUAvalve
- 9mm Top Hat (TH) Grommet
- 9mm pipe
- 9mm Inline Tap
- 16mm Click Fit Filter
- 9mm Golf Filter
- 16mm pipe
- 16mm Inline Tap

# SYSTEM SPECIFICATIONS

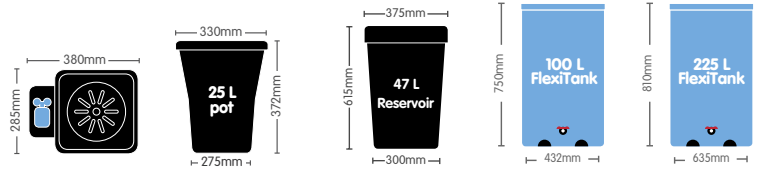

- 16mm Cross Connector
- 16-9mm Cross Connector
- 9mm Cross Connector
- 16mm Tee Connector
- 16-9mm Tee Connector
- 9mm Tee Connector

## 1POTXL SYSTEM - AP300/XL/1

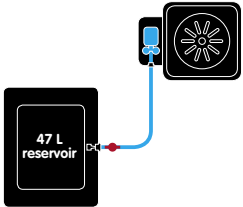

**CONTENTS**

1x 47 L reservoir & lid	1x 9mm inline tap
2x 9mm TH grommet	1x AQUAvalve5
1x 9mm golf filter	1.5 m of 9mm pipe
1x 1Pot XL tray & lid	1x XL root control disc
1x 25 L pot	1x instruction sheet

**FLOORSPACE REQUIREMENTS: 0.8M x 0.8M EX. RES.**

## 2POTXL SYSTEM - AP300/XL/2

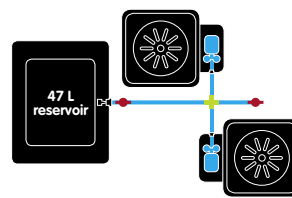

**CONTENTS**

1x 47 L reservoir & lid	2x AQUAvalve5
3x 9mm TH grommet	1x 9mm cross connector
1x 9mm golf filter	2 m of 9mm pipe
2x 1Pot XL tray & lid	2x XL root control disc
2x 25 L pot	1x instruction sheet
2x 9mm inline tap	

**FLOORSPACE REQUIREMENTS: 1M x 1M EX. RES.**

## 4POTXL SYSTEM - AP300/XL/4

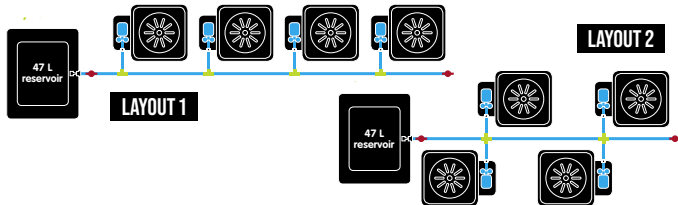

**CONTENTS**

1x 47 L reservoir & lid	1x 9mm golf filter	4x AQUAvalve5	4 m of 9mm pipe
4x 1Pot XL tray & lid	4x 25 L pot	2x 9mm cross connector	4x XL root control disc
5x 9mm TH grommet	2x 9mm inline tap	4x 9mm tee connector	1x instruction sheet

**FLOORSPACE REQUIREMENTS: 1.2M x 1.2M EX. RES.**

## 6POTXL SYSTEM - AP300/XL/6

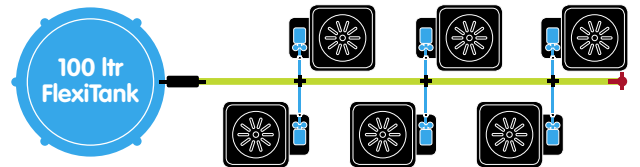

**CONTENTS**

1x 100 L FlexiTank	6x 9mm TH grommet	6x AQUAvalve5	3 m of 16mm pipe
6x 1Pot XL tray & lid	6x 25 L pot	3x 16-9mm cross connector	6x XL root control disc
1x 16mm click-fit filter	1x 16mm inline tap	3 m of 9mm pipe	1x instruction sheet

**FLOORSPACE REQUIREMENTS: 1.5M x 2M EX. RES.**

## 8POTXL SYSTEM - AP300/XL/8

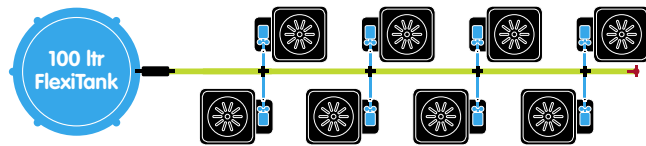

**CONTENTS**

1x 100 L FlexiTank	8x 25 L pot	8x AQUAvalve5	4 m of 16mm pipe
8x 1Pot XL tray & lid	8x 9mm TH grommet	4x 16-9mm cross connector	8x XL root control disc
1x 16mm click-fit filter	1x 16mm inline tap	4 m of 9mm pipe	1x instruction sheet

**FLOORSPACE REQUIREMENTS: 1.5M x 3M EX. RES.**

## 9POTXL SYSTEM - AP300/XL/9

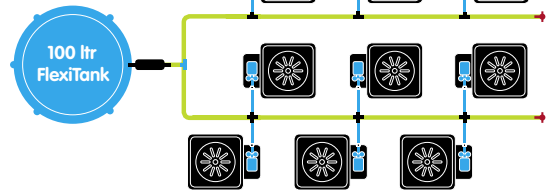

**CONTENTS**

1x 100 L FlexiTank	9x 9mm TH grommet	1x 16mm tee connector	6 m of 16mm pipe
9x 1Pot XL tray & lid	2x 16mm inline tap	3x 16-9mm tee connector	9x XL root control disc
1x 16mm click-fit filter	9x AQUAvalve5	4.5 m of 9mm pipe	1x instruction sheet
9x 25 L pot	3x 16-9mm cross connector		

**FLOORSPACE REQUIREMENTS: 2M x 2M EX. RES.**

## 12POTXL SYSTEM - AP300/XL/12

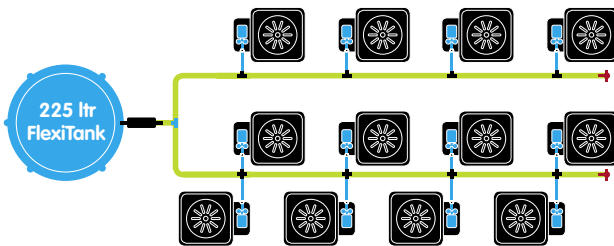

**CONTENTS**

1x 225 L FlexiTank	12x 9mm TH grommet	4x 16-9mm cross connector	8 m of 16mm pipe
12x 1Pot XL tray & lid	2x 16mm inline tap	4x 16-9mm tee connector	12x XL root control disc
1x 16mm click-fit filter	12x AQUAvalve5	6 m of 9mm pipe	1x instruction sheet
12x 25 L pot	1x 16mm tee connector		

**FLOORSPACE REQUIREMENTS: 2M x 3M EX. RES.**

## 16POTXL SYSTEM - AP300/XL/16

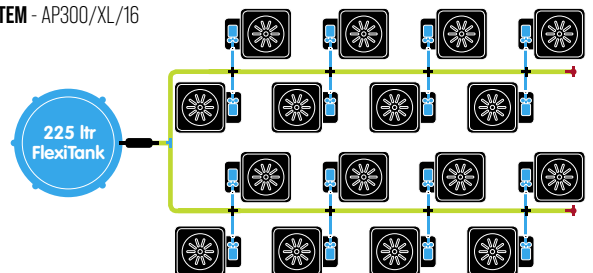

**CONTENTS**

1x 225 L FlexiTank	16x 9mm TH grommet	1x 16mm tee connector	8 m of 16mm pipe
16x 1Pot XL tray & lid	2x 16mm inline tap	8x 16-9mm cross connector	16x XL root control disc
1x 16mm click-fit filter	16x AQUAvalve5	8 m of 9mm pipe	1x instruction sheet
16x 25 L pot			

**FLOORSPACE REQUIREMENTS: 2.5M x 3.5M EX. RES.**



24POTXL SYSTEM - AP300/XL/24

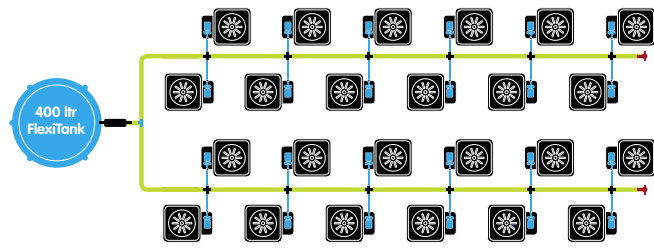

CONTENTS

- |                          |                            |                          |
|--------------------------|----------------------------|--------------------------|
| 1x 400 L FlexiTank       | 24x 9mm TH grommet         | 24x AQUAvalve5           |
| 24x 1Pot XL tray & lid   | 1x 16mm tee connector      | 24x XL root control disc |
| 1x 16mm click-fit filter | 12x 16-9mm cross connector | 12 m of 9mm pipe         |
| 2x 16mm inline tap       | 24x 25 L pot               | 10 m of 16mm pipe        |
|                          |                            | 1x instruction sheet     |

FLOORSPACE REQUIREMENTS: 3.5M x 3.5M EX. RES.



36POTXL SYSTEM - AP300/XL/36

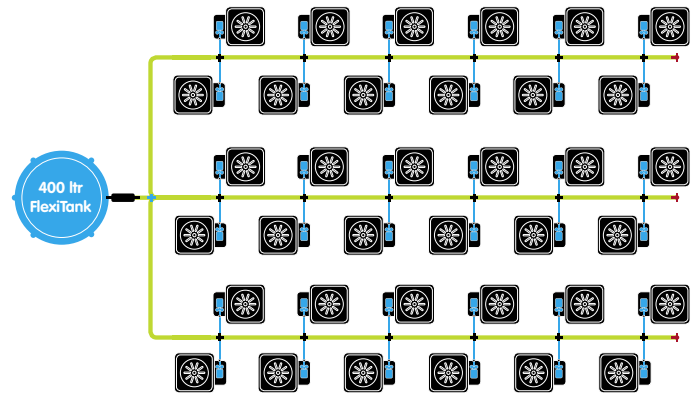

CONTENTS

- |                          |                            |                          |
|--------------------------|----------------------------|--------------------------|
| 1x 400 L FlexiTank       | 36x 9mm TH grommet         | 36x AQUAvalve5           |
| 36x 1Pot XL tray & lid   | 1x 16mm cross connector    | 36x XL root control disc |
| 1x 16mm click-fit filter | 18x 16-9mm cross connector | 18 m of 9mm pipe         |
| 3x 16mm inline tap       | 36x 25 L pot               | 15 m of 16mm pipe        |
|                          |                            | 1x instruction sheet     |

FLOORSPACE REQUIREMENTS: 3.5M x 5M EX. RES.



48POTXL SYSTEM - AP300/XL/48

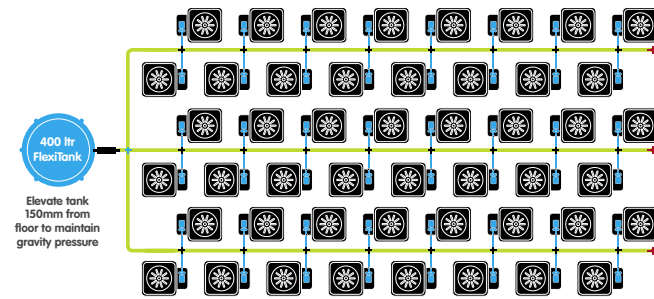

CONTENTS

- |                          |                            |                          |
|--------------------------|----------------------------|--------------------------|
| 1x 400 L FlexiTank       | 48x 9mm TH grommet         | 48x AQUAvalve5           |
| 48x 1Pot XL tray & lid   | 1x 16mm cross connector    | 48x XL root control disc |
| 1x 16mm click-fit filter | 24x 16-9mm cross connector | 24 m of 9mm pipe         |
| 3x 16mm inline tap       | 48x 25 L pot               | 20 m of 16mm pipe        |
|                          |                            | 1x instruction sheet     |

FLOORSPACE REQUIREMENTS: 5M x 5M EX. RES.



60POTXL SYSTEM - AP300/XL/60

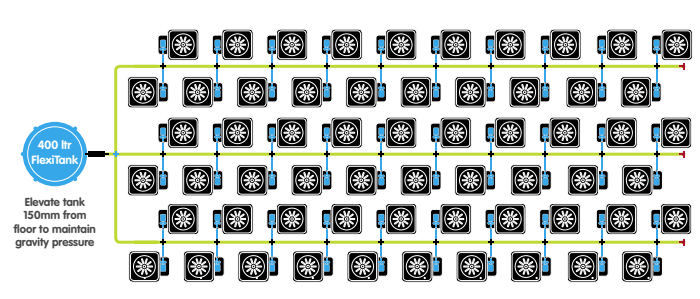

CONTENTS

- |                          |                            |                          |
|--------------------------|----------------------------|--------------------------|
| 1x 400 L FlexiTank       | 60x 9mm TH grommet         | 60x AQUAvalve5           |
| 60x 1Pot XL tray & lid   | 1x 16mm cross connector    | 60x XL root control disc |
| 1x 16mm click-fit filter | 30x 16-9mm cross connector | 30 m of 9mm pipe         |
| 3x 16mm inline tap       | 60x 25 L pot               | 25 m of 16mm pipe        |
|                          |                            | 1x instruction sheet     |

FLOORSPACE REQUIREMENTS: 7M x 4.5M EX. RES.



80POTXL SYSTEM - AP300/XL/80

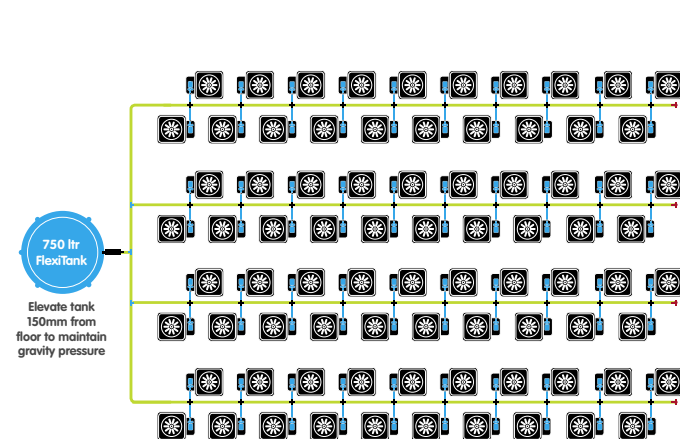

CONTENTS

- |                          |                            |                          |
|--------------------------|----------------------------|--------------------------|
| 1x 750 L FlexiTank       | 80x 9mm TH grommet         | 80x AQUAvalve5           |
| 80x 1Pot XL tray & lid   | 3x 16mm tee connector      | 80x XL root control disc |
| 1x 16mm click-fit filter | 40x 16-9mm cross connector | 40 m of 9mm pipe         |
| 4x 16mm inline tap       | 80x 25 L pot               | 30 m of 16mm pipe        |
|                          |                            | 1x instruction sheet     |

FLOORSPACE REQUIREMENTS: 6.5M x 6M EX. RES.



100POTXL SYSTEM - AP300/XL/100

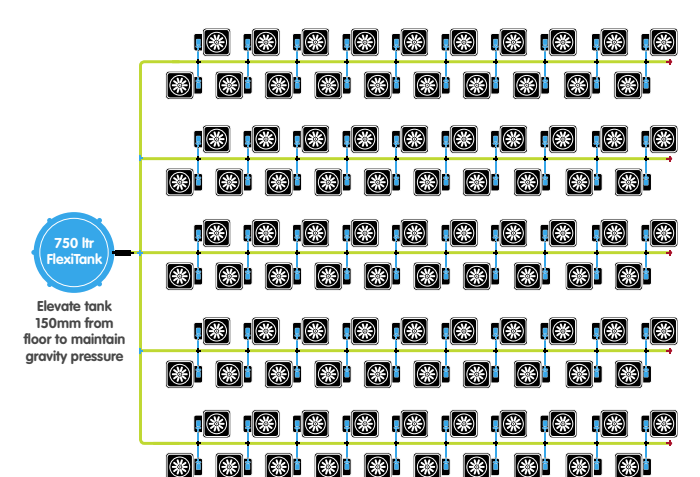

CONTENTS

- |                          |                            |                           |
|--------------------------|----------------------------|---------------------------|
| 1x 750 L FlexiTank       | 2x 16mm tee connector      | 100x 25 L pot             |
| 100x 1Pot XL tray & lid  | 100x 9mm TH grommet        | 100x AQUAvalve5           |
| 1x 16mm click-fit filter | 1x 16mm cross connector    | 100x XL root control disc |
| 5x 16mm inline tap       | 50x 16-9mm cross connector | 50 m of 9mm pipe          |
|                          |                            | 40 m of 16mm pipe         |
|                          |                            | 1x instruction sheet      |

FLOORSPACE REQUIREMENTS: 6.5M x 6.5M EX. RES.



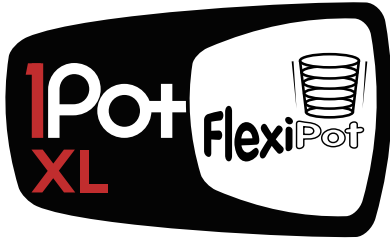

**GROW IN FABRIC WITH AUTOPOT & THE INNOVATIVE NEW FLEXIPOT RANGE**

**GET BIGGER, STRONGER, FASTER GROWING PLANTS**

**FOR AIR-PRUNING, ZERO ROOT-CIRCLING & INCREASED OXYGENATION OF ROOT ZONE**



### **THE ORIGINAL FLEXIPOT**

AutoPot XL FlexiPot module takes the immense capacity and versatility of the 1Pot XL tray and incorporates the innovative new fabric FlexiPot. These 20 L BPA-free, Lead-free pots are guaranteed against off-gassing or leaching and provide a uniquely rigid base to help keep plants upright.

**E: MAIL@AUTOPOT.CO.UK**

### **BIGGER, STRONGER PLANTS, FAST**

FlexiPot's porous fabric sides mean air-pruning and zero root circling - giving you bigger plants from smaller pots. Increased secondary feeder roots vastly improve nutrient & water uptake. Increased oxygen exchange in the substrate helps to supercharge plant growth.

**🌐 AUTOPOT.CO.UK**

### **EASY TO SHIP, SELL & STORE**

XL FlexiPot packs down 50% smaller and 50% lighter. This equates to huge reductions in shipping costs. The systems require less warehouse and shelf space and are easy for growers to transport and store. FlexiPots are incredibly durable and can be reused repeatedly for years.

**📷 @AUTOPOT\_GLOBAL**

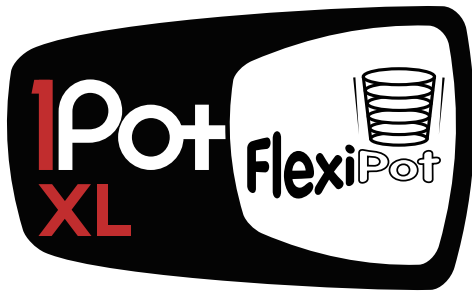

**ALL SYSTEMS COMPLETE WITH PIPEWORK & FITTINGS**

**ASK YOUR STOCKIST FOR FLEXITANK PRO OPTIONS**

**RRP - RECOMMENDED RETAIL PRICE**



**FOR FLOOR SPACE REQUIREMENTS SEE PAGES: 28-29**



**FLEXIPOT 1 SYSTEM - APSMART/1** with 47L reservoir  
RRP £53.00



**FLEXIPOT 2 SYSTEM - APSMART/2** with 47L reservoir  
RRP £83.50



**FLEXIPOT 4 SYSTEM - APSMART/4** with 47L reservoir  
RRP £150.00



**FLEXIPOT 6 SYSTEM - APSMART/6** with 100L FlexiTank  
RRP £240.00



**FLEXIPOT 8 SYSTEM - APSMART/8** with 100L FlexiTank  
RRP £305.00



**FLEXIPOT 9 SYSTEM - APSMART/9** with 100L FlexiTank  
RRP £340.00



**FLEXIPOT 12 SYSTEM - APSMART/12** with 225L FlexiTank  
RRP £455.00



**FLEXIPOT 16 SYSTEM - APSMART/16** with 225L FlexiTank  
RRP £590.00



**FLEXIPOT 24 SYSTEM - APSMART/24** with 400L FlexiTank  
RRP £880.00



**FLEXIPOT 36 SYSTEM - APSMART/36** with 400L FlexiTank  
RRP £1,220.00



**FLEXIPOT 48 SYSTEM - APSMART/48** with 400L FlexiTank  
RRP £1,560.00



**FLEXIPOT 60 SYSTEM - APSMART/60** with 400L FlexiTank  
RRP £1,845.00



**FLEXIPOT 80 SYSTEM - APSMART/80** with 750L FlexiTank  
RRP £2,380.00



**FLEXIPOT 100 SYSTEM - APSMART/100** with 750L FlexiTank  
RRP £2,890.00

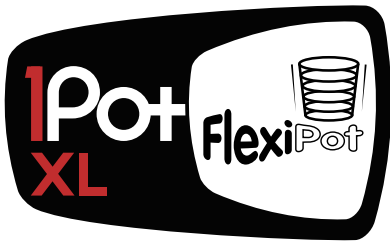

9mm pipe - Outside ø 9mm/Inside ø 7mm    16mm pipe - Outside ø 16mm/Inside ø 13mm

- AQUAvalve
- 9mm Top Hat (TH) Grommet
- 9mm pipe
- 9mm Inline Tap
- 16mm Click Fit Filter
- 9mm Golf Filter
- 16mm pipe
- 16mm Inline Tap

# SYSTEM SPECIFICATIONS

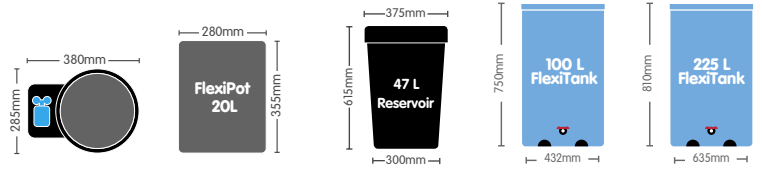

- 16mm Cross Connector
- 16-9mm Cross Connector
- 9mm Cross Connector
- 16mm Tee Connector
- 16-9mm Tee Connector
- 9mm Tee Connector

## FLEXIPOT 1 SYSTEM - APSMART/1

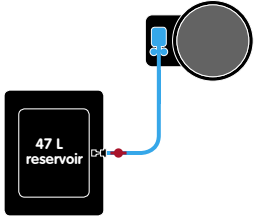

**CONTENTS**

1x 47 L reservoir & lid	1x 9mm inline tap
2x 9mm TH grommet	1x AQUAvalve5
1x 9mm golf filter	1.5 m of 9mm pipe
1x 1Pot XL tray & lid	1x PotSock Round
1x 20 L fabric FlexiPot	1x instruction sheet

**FLOORSPACE REQUIREMENTS: 0.8M x 0.8M EX. RES.**

## FLEXIPOT 2 SYSTEM - APSMART/2

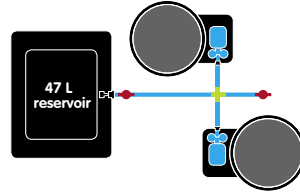

**CONTENTS**

1x 47 L reservoir & lid	2x AQUAvalve5
3x 9mm TH grommet	1x 9mm cross connector
1x 9mm golf filter	2 m of 9mm pipe
2x 1Pot XL tray & lid	2x PotSock Round
2x 20 L fabric FlexiPot	2x 9mm inline tap
1x instruction sheet	

**FLOORSPACE REQUIREMENTS: 1M x 1M EX. RES.**

## FLEXIPOT 4 SYSTEM - APSMART/4

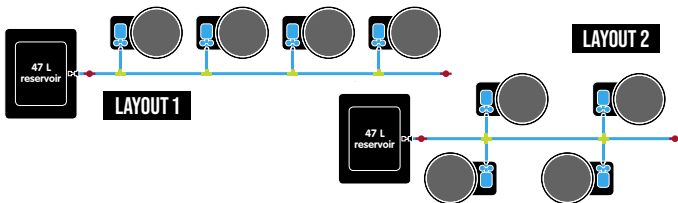

**CONTENTS**

1x 47 L reservoir & lid	1x 9mm golf filter	4x AQUAvalve5	4 m of 9mm pipe
4x 1Pot XL tray & lid	4x 20 L fabric FlexiPot	2x 9mm cross connector	4x PotSock Round
5x 9mm TH grommet	2x 9mm inline tap	4x 9mm tee connector	1x instruction sheet

**FLOORSPACE REQUIREMENTS: 1.2M x 1.2M EX. RES.**

## FLEXIPOT 6 SYSTEM - APSMART/6

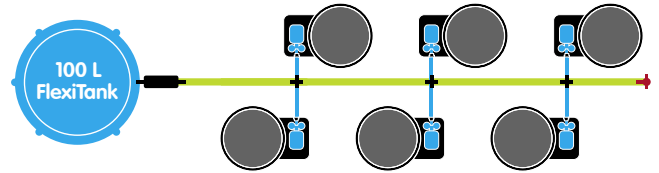

**CONTENTS**

1x 100 L FlexiTank	6x 9mm TH grommet	6x AQUAvalve5	3 m of 16mm pipe
6x 1Pot XL tray & lid	6x 20 L fabric FlexiPot	3x 16-9mm cross connector	6x PotSock Round
1x 16mm click-fit filter	1x 16mm inline tap	3 m of 9mm pipe	1x instruction sheet

**FLOORSPACE REQUIREMENTS: 1.5M x 2M EX. RES.**

## FLEXIPOT 8 SYSTEM - APSMART/8

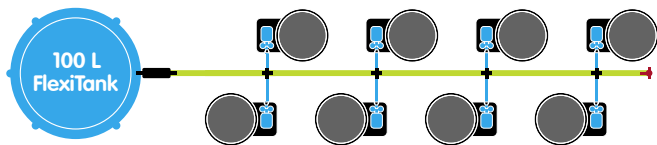

**CONTENTS**

1x 100 L FlexiTank	8x 9mm TH grommet	8x AQUAvalve5	4 m of 16mm pipe
8x 1Pot XL tray & lid	8x 20 L fabric FlexiPot	4x 16-9mm cross connector	8x PotSock Round
1x 16mm click-fit filter	1x 16mm inline tap	4 m of 9mm pipe	1x instruction sheet

**FLOORSPACE REQUIREMENTS: 1.5M x 3M EX. RES.**

## FLEXIPOT 9 SYSTEM - APSMART/9

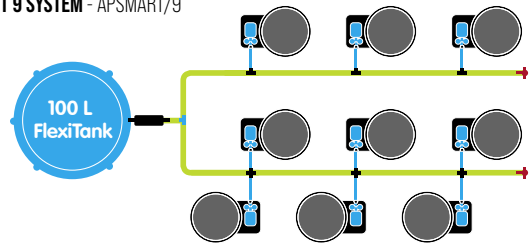

**CONTENTS**

1x 100 L FlexiTank	9x 9mm TH grommet	1x 16mm tee connector	6 m of 16mm pipe
9x 1Pot XL tray & lid	2x 16mm inline tap	3x 16-9mm tee connector	9x PotSock Round
1x 16mm click-fit filter	9x AQUAvalve5	4.5 m of 9mm pipe	1x instruction sheet
9x 20 L fabric FlexiPot	3x 16-9mm cross connector		

**FLOORSPACE REQUIREMENTS: 2M x 2M EX. RES.**

## FLEXIPOT 12 SYSTEM - APSMART/12

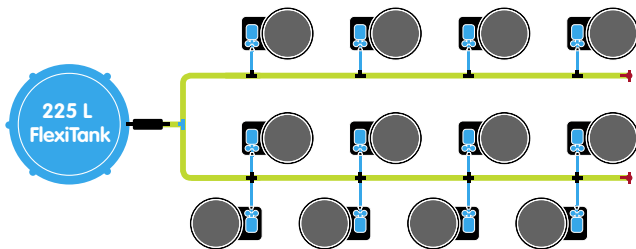

**CONTENTS**

1x 225 L FlexiTank	12x 9mm TH grommet	4x 16-9mm cross connector	8 m of 16mm pipe
12x 1Pot XL tray & lid	2x 16mm inline tap	4x 16-9mm tee connector	12x PotSock Round
1x 16mm click-fit filter	12x AQUAvalve5	6 m of 9mm pipe	1x instruction sheet
12x 20 L fabric FlexiPot	1x 16mm tee connector		

**FLOORSPACE REQUIREMENTS: 2M x 3M EX. RES.**

## FLEXIPOT 16 SYSTEM - APSMART/16

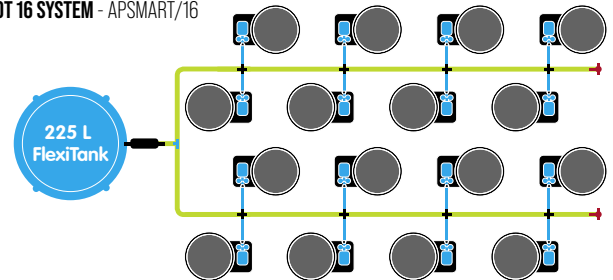

**CONTENTS**

1x 225 L FlexiTank	16x 9mm TH grommet	1x 16mm tee connector	8 m of 16mm pipe
16x 1Pot XL tray & lid	2x 16mm inline tap	8x 16-9mm cross connector	16x PotSock Round
1x 16mm click-fit filter	16x AQUAvalve5	8 m of 9mm pipe	1x instruction sheet
16x 20 L fabric FlexiPot			

**FLOORSPACE REQUIREMENTS: 2.5M x 3.5M EX. RES.**

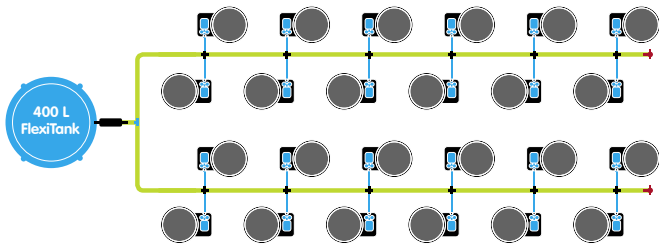

**CONTENTS**

1x 400 L FlexiTank	24x 9mm TH grommet	24x AQUAvalve5
24x 1Pot XL tray & lid	1x 16mm tee connector	24x PotSock Round
1x 16mm click-fit filter	12x 16-9mm cross connector	12 m of 9mm pipe
2x 16mm inline tap	24x 20 L fabric FlexiPot	10 m of 16mm pipe
		1x instruction sheet

**FLOORSPACE REQUIREMENTS: 3.5M x 3.5M EX. RES.**

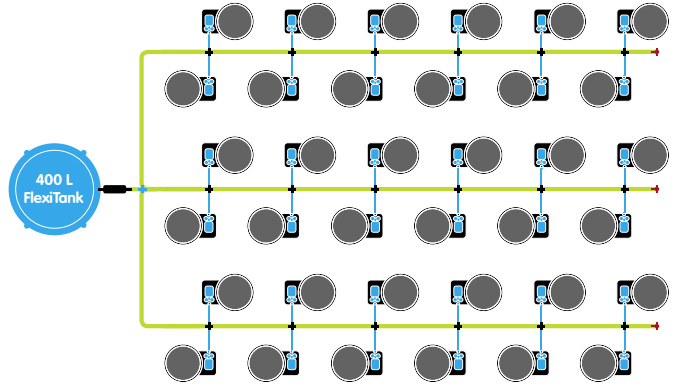

**CONTENTS**

1x 400 L FlexiTank	36x 9mm TH grommet	36x AQUAvalve5
36x 1Pot XL tray & lid	1x 16mm cross connector	36x PotSock Round
1x 16mm click-fit filter	18x 16-9mm cross connector	18 m of 9mm pipe
3x 16mm inline tap	36x 20 L fabric FlexiPot	15 m of 16mm pipe
		1x instruction sheet

**FLOORSPACE REQUIREMENTS: 3.5M x 5M EX. RES.**

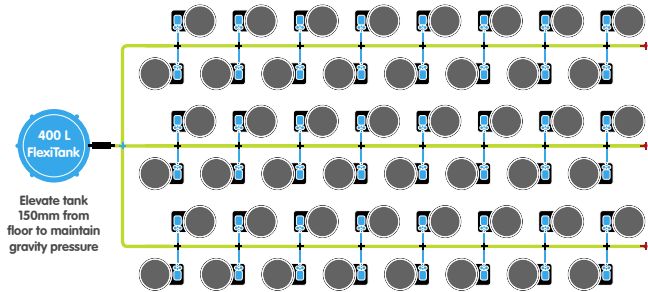

**CONTENTS**

1x 400 L FlexiTank	48x 9mm TH grommet	48x AQUAvalve5
48x 1Pot XL tray & lid	1x 16mm cross connector	48x PotSock Round
1x 16mm click-fit filter	24x 16-9mm cross connector	24 m of 9mm pipe
3x 16mm inline tap	48x 20 L fabric FlexiPot	20 m of 16mm pipe
		1x instruction sheet

**FLOORSPACE REQUIREMENTS: 5M x 5M EX. RES.**

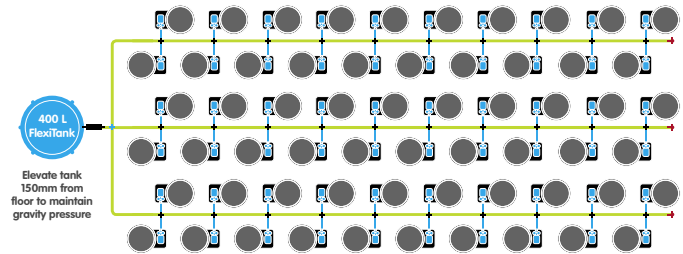

**CONTENTS**

1x 400 L FlexiTank	60x 9mm TH grommet	60x AQUAvalve5
60x 1Pot XL tray & lid	1x 16mm cross connector	60x PotSock Round
1x 16mm click-fit filter	30x 16-9mm cross connector	30 m of 9mm pipe
3x 16mm inline tap	60x 20 L fabric FlexiPot	25 m of 16mm pipe
		1x instruction sheet

**FLOORSPACE REQUIREMENTS: 7M x 4.5M EX. RES.**

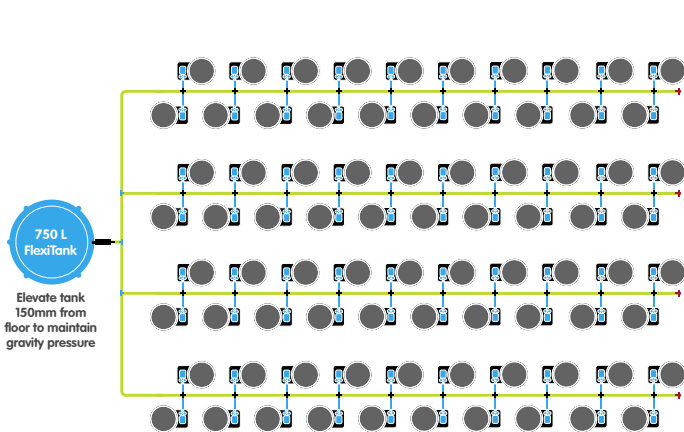

**CONTENTS**

1x 750 L FlexiTank	80x 9mm TH grommet	80x AQUAvalve5
80x 1Pot XL tray & lid	3x 16mm tee connector	80x PotSock Round
1x 16mm click-fit filter	40x 16-9mm cross connector	40 m of 9mm pipe
4x 16mm inline tap	80x 20 L fabric FlexiPot	30 m of 16mm pipe
		1x instruction sheet

**FLOORSPACE REQUIREMENTS: 6.5M x 6M EX. RES.**

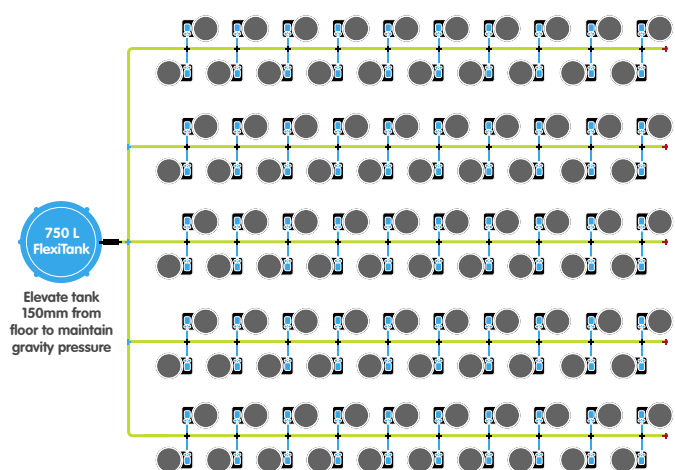

**CONTENTS**

1x 750 L FlexiTank	100x 9mm TH grommet	100x 20 L fabric FlexiPot
100x 1Pot XL tray & lid	2x 16mm tee connector	100x AQUAvalve5
1x 16mm click-fit filter	1x 16mm cross connector	100x PotSock Round
5x 16mm inline tap	50x 16-9mm cross connector	50 m of 9mm pipe
		40 m of 16mm pipe
		1x instruction sheet

**FLOORSPACE REQUIREMENTS: 6.5M x 6.5M EX. RES.**

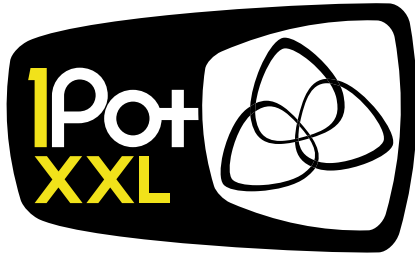

FOR THE BIGGEST, MOST FRUITFUL PLANTS IMAGINABLE

RESPONSIVE, POWER-FREE IRRIGATION & FEEDING FOR BIG PLANT GROWERS

SWITCH BETWEEN 35L AND 50L FABRIC POTS AT WILL



### KNOW NO LIMITS

AutoPot XXL propels you into a new world of horticultural possibility, backed with technology that's proven to make the wildest, most fantastical, most fruitful plants a reality.

At last, a power-free watering system for 35 L and 50 L growers that truly satisfies the needs of their plants.

### ADAPT TO ANYTHING

An ingenious enlargement of our ever-popular XL module, XXL accommodates 35L or 50L fabric pots. An adaptive collar even allows growers to switch between pot sizes as required whilst still using the same tray. XXL35 comes with BPA-free, Lead-free, fabric FlexiPots, XXL50 comes with identically specced 50 L versions.

### GROW WITH XXL

Cultivating big plants, whether one or many, requires time and technique. XXL brings ultra-low maintenance, plant-controlled AQUAvalve5 irrigation and feeding into the realm of giant growing - giving you the opportunity and head space to hone your horticultural skills.

E: MAIL@AUTOPOT.CO.UK

🌐 AUTOPOT.CO.UK

📷 @AUTOPOT\_GLOBAL

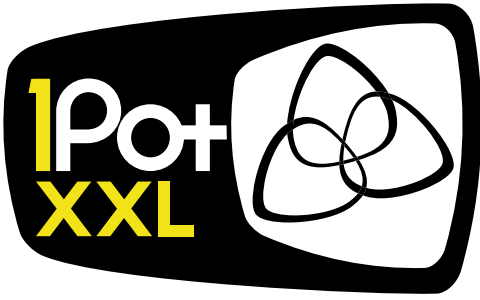

**ALL SYSTEMS COMPLETE WITH PIPEWORK & FITTINGS**

**ASK YOUR STOCKIST FOR FLEXITANK PRO OPTIONS**

**RRP - RECOMMENDED RETAIL PRICE**

**FOR FLOOR SPACE REQUIREMENTS SEE PAGES: 32-33**



with 47L reservoir

1POT XXL35 - APXXL/35L/1 RRP £63.65  
1POT XXL50 - APXXL/50L/1 RRP £63.65



with 47L reservoir

2POT XXL35 - APXXL/35L/2 RRP £106.50  
2POT XXL50 - APXXL/50L/2 RRP £106.50



with 47L reservoir

4POT XXL35 - APXXL/35L/4 RRP £187.00  
4POT XXL50 - APXXL/50L/4 RRP £187.00



with 100L FlexiTank

6POT XXL35 - APXXL/35L/6 RRP £310.00  
6POT XXL50 - APXXL/50L/6 RRP £310.00



with 225L FlexiTank

8POT XXL35 - APXXL/35L/8 RRP £385.00  
8POT XXL50 - APXXL/50L/8 RRP £385.00



with 225L FlexiTank

9POT XXL35 - APXXL/35L/9 RRP £430.00  
9POT XXL50 - APXXL/50L/9 RRP £430.00



with 225L FlexiTank

12POT XXL35 - APXXL/35L/12 RRP £565.00  
12POT XXL50 - APXXL/50L/12 RRP £565.00



with 225L FlexiTank

16POT XXL35 - APXXL/35L/16 RRP £720.00  
16POT XXL50 - APXXL/50L/16 RRP £720.00



with 225L FlexiTank

24POT XXL35 - APXXL/35L/24 RRP £1,085.00  
24POT XXL50 - APXXL/50L/24 RRP £1,085.00



with 400L FlexiTank

36POT XXL35 - APXXL/35L/36 RRP £1,550.00  
36POT XXL50 - APXXL/50L/36 RRP £1,550.00



with 400L FlexiTank

48POT XXL35 - APXXL/35L/48 RRP £1,995.00  
48POT XXL50 - APXXL/50L/48 RRP £1,995.00



with 400L FlexiTank

60POT XXL35 - APXXL/35L/60 RRP £2,395.00  
60POT XXL50 - APXXL/50L/60 RRP £2,395.00



with 750L FlexiTank

80POT XXL35 - APXXL/35L/80 RRP £2,995.00  
80POT XXL50 - APXXL/50L/80 RRP £2,995.00



with 750L FlexiTank

100POT XXL35 - APXXL/35L/100 RRP £3,495.00  
100POT XXL50 - APXXL/50L/100 RRP £3,495.00

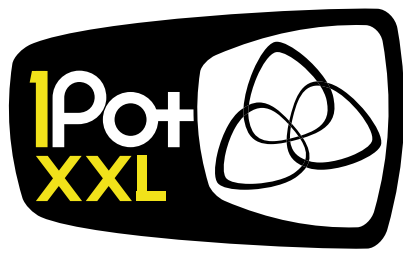

- 9mm pipe - Outside ø 9mm/Inside ø 7mm    16mm pipe - Outside ø 16mm/Inside ø 13mm
- AQUAvalve
  - 9mm Top Hat (TH) Grommet
  - 9mm pipe
  - 9mm Inline Tap
  - 16mm Click Fit Filter
  - 9mm Golf Filter
  - 16mm pipe
  - 16mm Inline Tap

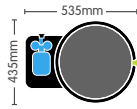

- FlexiPot 35L
  - FlexiPot 50L
  - 47 L Reservoir
  - 100 L FlexiTank
  - 225 L FlexiTank
- 16mm Cross Connector
  - 16-9mm Cross Connector
  - 9mm Cross Connector
  - 6mm Blanking Grommet
  - 16mm Tee Connector
  - 16-9mm Tee Connector
  - 9mm Tee Connector

**1POT XXL35 SYSTEM (35L POT) - APXXL/35/1 - or 1POT XXL50 SYSTEM\* (50L POT) - APXXL/50/1**

**CONTENTS**

1x 47 L reservoir & lid	1x AQUAvalve5
1x XXL tray & lid	1.5 m of 9mm pipe
2x 9mm TH grommet	1x PotSock Round
1x 9mm golf filter	1x 35 L / *50 L fabric pot
1x 9mm inline tap	1x adaptive collar (XXL35 only)

1x 6mm blanking grommet

**FLOORSPACE REQUIREMENTS: 1M x 1M EX. RES.**

**2POT XXL35 SYSTEM (35L POTS) - APXXL/35/2 - or 2POT XXL50 SYSTEM\* (50L POTS) - APXXL/50/2**

**CONTENTS**

1x 47 L reservoir & lid	1x 9mm cross connector
2x XXL tray & lid	2x 6mm blanking grommet
3x 9mm TH grommet	2 m of 9mm pipe
1x 9mm golf filter	2x PotSock Round
2x 9mm inline tap	2x 35 L / *50 L fabric pot
2x AQUAvalve5	2x adaptive collar (XXL35 only)

**FLOORSPACE REQUIREMENTS: 1.5M x 1.5M EX. RES.**

**4POT XXL35 SYSTEM (35L POTS) - APXXL/35/4 - or 4POT XXL50 SYSTEM\* (50L POTS) - APXXL/50/4**

**CONTENTS**

1x 47 L reservoir & lid	1x 9mm golf filter	4x AQUAvalve5	4x PotSock Round
4x XXL tray & lid	4x 35 L / *50 L fabric pot	2x 9mm cross connector	4 m of 9mm pipe
5x 9mm TH grommet	2x 9mm inline tap	4x 9mm tee connector	4x adaptive collar (XXL35 only)
5x 6mm blanking grommet			

**FLOORSPACE REQUIREMENTS: 2M x 2M EX. RES.**

**6POT XXL35 SYSTEM (35L POTS) - APXXL/35/6 - or 6POT XXL50 SYSTEM\* (50L POTS) - APXXL/50/6**

**CONTENTS**

1x 100 L FlexiTank	1x 16mm click fit filter	6x AQUAvalve5	3m of 16mm pipe
6x XXL tray & lid	6x 35 L / *50 L fabric pot	3x 16-9mm cross connector	6x PotSock Round
6x 9mm TH grommet	1x 16mm inline tap	3m of 9mm pipe	6x adaptive collar (XXL35 only)
6x 6mm blanking grommet			

**FLOORSPACE REQUIREMENTS: 3M x 2M EX. RES.**

**8POT XXL35 SYSTEM (35L POTS) - APXXL/35/8 - or 8POT XXL50 SYSTEM\* (50L POTS) - APXXL/50/8**

**CONTENTS**

1x 100 L FlexiTank	1x 16mm click fit filter	8x AQUAvalve5	4m of 16mm pipe
8x XXL tray & lid	8x 35 L / *50 L fabric pot	4x 16-9mm cross connector	8x PotSock Round
8x 9mm TH grommet	1x 16mm inline tap	4m of 9mm pipe	8x adaptive collar (XXL35 only)
8x 6mm blanking grommet			

**FLOORSPACE REQUIREMENTS: 4M x 2M EX. RES.**

**9POT XXL35 SYSTEM (35L POTS) APXXL/35/9**

or **9POT XXL50 SYSTEM\* (50L POTS) APXXL/50/9**

**CONTENTS**

1x 100 L FlexiTank	1x 16mm click fit filter	1x 16mm tee connector	4.5m of 9mm pipe
9x XXL tray & lid	9x 35 L / *50 L fabric pot	3x 16-9mm cross connector	6m of 16mm pipe
9x 9mm TH grommet	2x 16mm inline tap	3x 16-9mm tee connector	9x PotSock Round
9x 6mm blanking grommet	9x AQUAvalve5	9x adaptive collar (XXL35 only)	

**FLOORSPACE REQUIREMENTS: 3M x 3M EX. RES.**

**12POT XXL35 SYSTEM (35L POTS) - APXXL/35/12 - or 12POT XXL50 SYSTEM\* (50L POTS) - APXXL/50/12**

**CONTENTS**

1x 225 L FlexiTank	1x 16mm click fit filter	1x 16mm tee connector	6m of 9mm pipe
12x XXL tray & lid	12x 35 L / *50 L fabric pot	4x 16-9mm cross connector	8m of 16mm pipe
12x 9mm TH grommet	2x 16mm inline tap	4x 16-9mm tee connector	12x PotSock Round
12x 6mm blanking grommet	12x AQUAvalve5	12x adaptive collar (XXL35 only)	

**FLOORSPACE REQUIREMENTS: 4M x 3M EX. RES.**

**16POT XXL35 SYSTEM (35L POTS) APXXL/35/16**

or **16POT XXL50 SYSTEM\* (50L POTS) APXXL/50/16**

**CONTENTS**

1x 225 L FlexiTank	16x 9mm TH grommet	1x 16mm tee connector	8 m of 9mm pipe
16x XXL tray & lid	16x 6mm blanking grommet	8x 16-9mm cross connector	8 m of 16mm pipe
1x 16mm click-fit filter	2x 16mm inline tap	16x adaptive collar (XXL35 only)	16x PotSock Round
16x 35 L / *50 L fabric pot	16x AQUAvalve5		

**FLOORSPACE REQUIREMENTS: 4M x 3.5M EX. RES.**



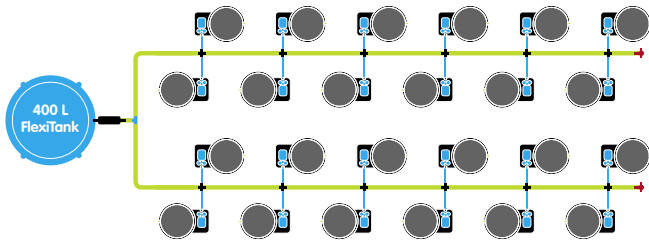

**CONTENTS**

- 1x 400 L FlexiTank
- 24x 9mm TH grommet
- 24x 35 L / \*50 L fabric pot
- 24x XXL tray & lid
- 24x 6mm blanking grommet
- 24x AQUAvalve5
- 1x 16mm click-fit filter
- 1x 16mm tee connector
- 24x PotSock Round
- 2x 16mm inline tap
- 24x 16-9mm cross connector
- 12 m of 9mm pipe
- 10 m of 16mm pipe
- 24x adaptive collar (XXL35 only)

FLOORSPACE REQUIREMENTS: 9M x 3.5M EX. RES.

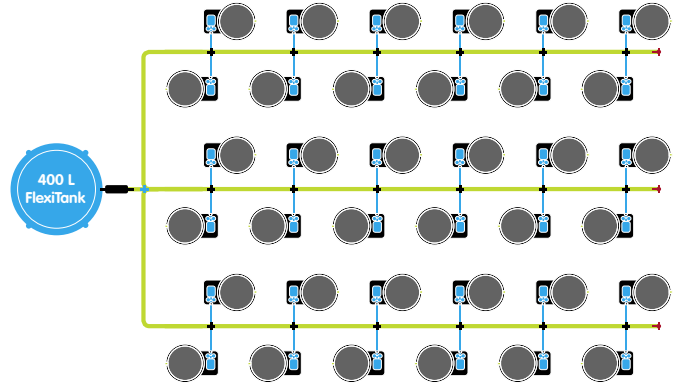
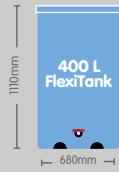

**CONTENTS**

- 1x 400 L FlexiTank
- 36x 9mm TH grommet
- 36x 35 L / \*50 L fabric pot
- 36x XXL tray & lid
- 36x 6mm blanking grommet
- 36x AQUAvalve5
- 1x 16mm click-fit filter
- 1x 16mm cross connector
- 36x PotSock Round
- 3x 16mm inline tap
- 18x 16-9mm cross connector
- 18 m of 9mm pipe
- 15 m of 16mm pipe
- 36x adaptive collar (XXL35 only)

FLOORSPACE REQUIREMENTS: 9M x 4.5M EX. RES.

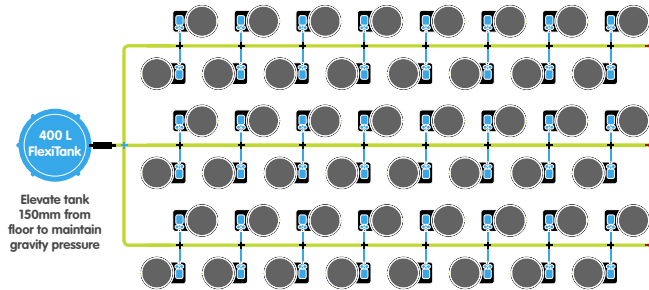
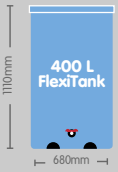

Elevate tank 150mm from floor to maintain gravity pressure

**CONTENTS**

- 1x 400 L FlexiTank
- 48x 9mm TH grommet
- 48x 35 L / 50 L\* fabric pot
- 48x XXL tray & lid
- 48x 6mm blanking grommet
- 48x AQUAvalve5
- 1x 16mm click-fit filter
- 1x 16mm cross connector
- 48x PotSock Round
- 3x 16mm inline tap
- 24x 16-9mm cross connector
- 24 m of 9mm pipe
- 20 m of 16mm pipe
- 48x adaptive collar (XXL35 only)

FLOORSPACE REQUIREMENTS: 12M x 4.5M EX. RES.

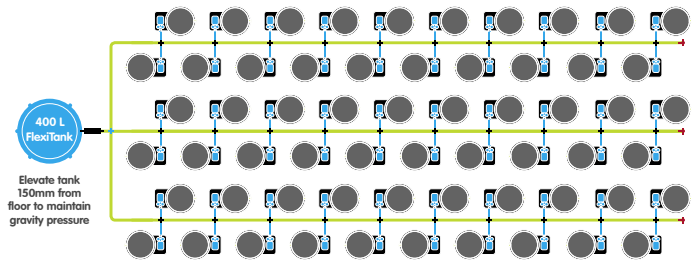
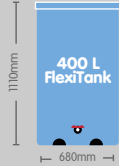

Elevate tank 150mm from floor to maintain gravity pressure

**CONTENTS**

- 1x 400 L FlexiTank
- 60x 9mm TH grommet
- 60x 35 L / \*50 L fabric pot
- 60x XXL tray & lid
- 60x 6mm blanking grommet
- 60x AQUAvalve5
- 1x 16mm click-fit filter
- 1x 16mm cross connector
- 60x PotSock Round
- 3x 16mm inline tap
- 30x 16-9mm cross connector
- 30 m of 9mm pipe
- 25 m of 16mm pipe
- 60x adaptive collar (XXL35 only)

FLOORSPACE REQUIREMENTS: 15M x 4.5M EX. RES.

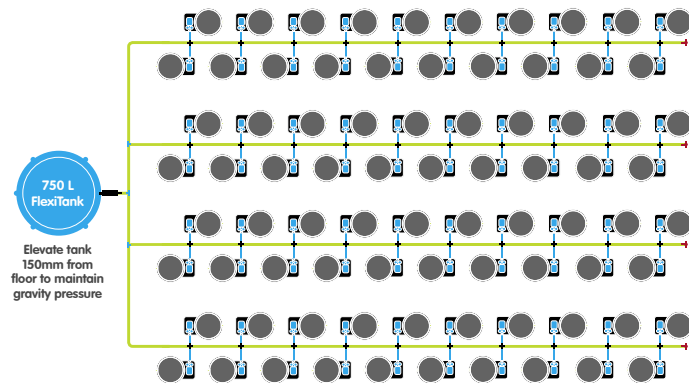

Elevate tank 150mm from floor to maintain gravity pressure

**CONTENTS**

- 1x 750 L FlexiTank
- 80x 6mm blanking grommet
- 80x PotSock Round
- 80x XXL tray & lid
- 3x 16mm tee connector
- 40 m of 9mm pipe
- 1x 16mm click-fit filter
- 40x 16-9mm cross connector
- 30 m of 16mm pipe
- 4x 16mm inline tap
- 80x 35 L / 50 L fabric pot
- 80x adaptive collar (XXL35 only)
- 80x 9mm TH grommet
- 80x AQUAvalve5

FLOORSPACE REQUIREMENTS: 15M x 6M EX. RES.

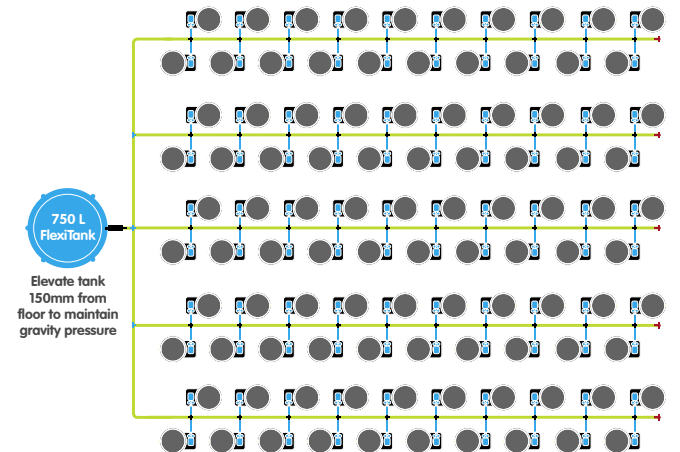

Elevate tank 150mm from floor to maintain gravity pressure

**CONTENTS**

- 1x 750 L FlexiTank
- 100x 6mm blanking grommet
- 100x 35 L / 50 L fabric pot
- 100x XXL tray & lid
- 2x 16mm tee connector
- 100x PotSock Round
- 1x 16mm click-fit filter
- 1x 16mm cross connector
- 50 m of 9mm pipe
- 5x 16mm inline tap
- 50x 16-9mm cross connector
- 40 m of 16mm pipe
- 100x 9mm TH grommet
- 100x AQUAvalve5
- 100x adaptive collar (XXL35 only)

FLOORSPACE REQUIREMENTS: 15M x 7.5M EX. RES.



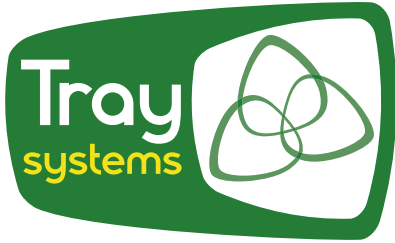

MAXIMISE GROWING SPACE, MINIMISE MAINTENANCE

MULTIPLE POTS IN A SINGLE TRAY & LID ASSEMBLY, ALL FED BY A SINGLE AQUAVALVE

TRAY SYSTEMS FOR EVERY STAGE OF ADULT PLANT GROWTH



## GROWING SPACE

Irrigate multiple pots in a single tray and lid assembly, all fed by a single AQUAvalve, radically reducing the footprint and system maintenance. Take advantage of all the space you have without the concern of accessing individual pots and trays. Ideal for tight spaces, rolling benches and vertical racking.

## OVERHEADS

Tray systems irrigate with zero run-off so don't require plumbing for waste water and fewer lights are needed with plants arranged less loosely. Fewer valves and fittings vastly reduces maintenance whilst the systems draw no more water than individual modules.

## PLANT HEALTH

All our Tray Systems incorporate moulded bases to minimise standing water whilst the lid blocks light and debris from entering tray. Use fabric pots with Auto XL FlexiPot for air-pruning, zero root-circling and bigger, faster growing plants from smaller pots. Use 8.5 L or 15 L pots with Auto8 for maximum flexibility.

E: MAIL@AUTOPOT.CO.UK

🌐 AUTOPOT.CO.UK

📷 @AUTOPOT\_GLOBAL



**AUTO9XL/XL RRP £304.30 >>**

Auto9 XL Includes:  
 1x Auto9 XL tray & lid, 1x AQUAvalve5, 1x AQUAvalve cover,  
 1x Round blue access cover, 1x 9mm top hat grommet,  
 1x metre 9mm piping, 9x 25 L XL plastic pot, 9x root control disc

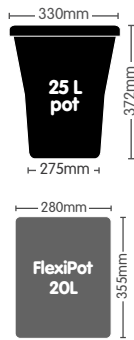
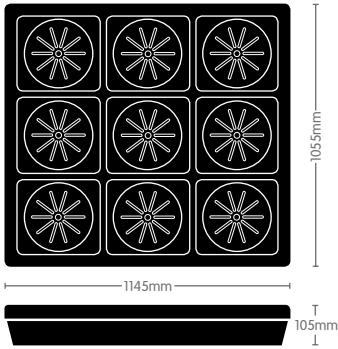

**<< AUTO9XL/SMART RRP £304.30**

Auto9 XL FlexiPot Includes:  
 1x Auto9 XL tray & lid, 1x AQUAvalve5, 1x AQUAvalve cover,  
 1x Round blue access cover, 1x 9mm top hat grommet,  
 1x metre 9mm piping, 9x 20 L fabric FlexiPots, 9x PotSock Round



**AUTO3XL/XL RRP £144.20 >>**

Auto3 XL Includes:  
 1x Auto3 XL tray & lid, 1x AQUAvalve5, 1x AQUAvalve cover,  
 1x Round blue access cover, 1x 9mm top hat grommet,  
 1x metre 9mm piping, 3x 25 L XL plastic pot, 3x root control disc

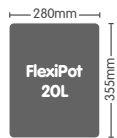
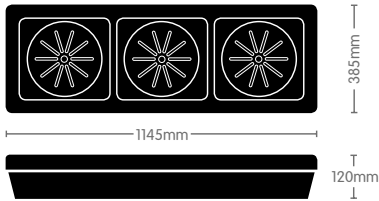

**<< AUTO3XL/SMART RRP £144.20**

Auto3 XL FlexiPot Includes:  
 1x Auto3 XL tray & lid, 1x AQUAvalve5, 1x AQUAvalve cover,  
 1x Round blue access cover, 1x 9mm top hat grommet,  
 1x metre 9mm piping, 3x 20 L fabric FlexiPots, 3x PotSock Round



**AUTO8/8.5 RRP £172.55 >>**

Auto8 8.5 L Includes:  
 1x Auto8 tray & lid, 1x AQUAvalve5, 1x AQUAvalve cover,  
 1x Round blue access cover, 1x 9mm top hat grommet, 1x metre 9mm  
 piping, 8x 8.5 L plastic pots, 8x Marix disc (Square), 8x PotSock Square

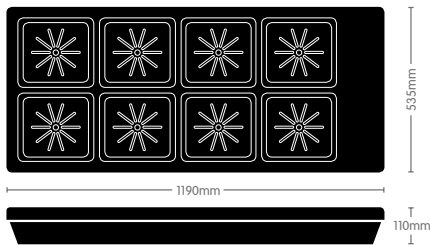

**<< AUTO8/15 RRP £182.15**

Auto8 15 L Includes:  
 1x Auto8 tray & lid, 1x AQUAvalve5, 1x AQUAvalve cover,  
 1x Round blue access cover, 1x 9mm top hat grommet,  
 1x metre 9mm piping, 8x 15 L plastic pots, 8x Marix disc (Square)  
 8x PotSock Square

**RRP = RECOMMENDED RETAIL PRICE**

**FOR RESERVOIRS SEE PAGES 52-55**



**MAXIMISE GROWING SPACE WITH AUTO5 - FOR TRULY HUGE PLANTS**

**FEED UP TO FIVE 35 L FABRIC POTS WITH A SINGLE AQUAVALVE**

**FABRIC POTS SPEED PLANT DEVELOPMENT - GET GROWING FASTER**

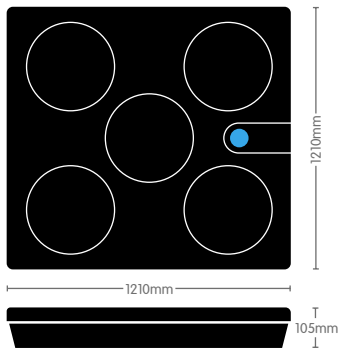

**AUTO5XL/SMART RRP £250.80 >>**

- Includes:*  
 1 x Auto5 Lid,  
 1 x 1.2m sq Garden Tray,  
 5 x 35L fabric FlexiPot,  
 1 x Round Blue Access Cover,  
 1 x AQUAvalve5,  
 1 x AQUAvalve Cover,  
 1 x AQUAvalve PotSock,  
 1 x Metal Plate for AQUAvalve PotSock,  
 1 x 9mm Top Hat Grommet,  
 1m of 9mm Pipe, 1x Drill Template

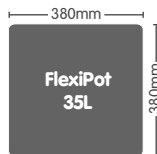

Auto5 - for large plants in fabric pots, maximises available growing space and minimises maintenance thanks to a single AQUAvalve5



**AUTO5 XL WITHOUT POTS**

**AUTO5XL/NP**

**RRP £206.80**

- Includes:*  
 1 x Auto5 Lid, 1 x 1.2m sq Garden Tray,  
 1 x Round Blue Access Cover, 1 x AQUAvalve5,  
 1 x AQUAvalve Cover, 1 x AQUAvalve PotSock,  
 1 x Metal Plate for AQUAvalve PotSock,  
 1 x 9mm Top Hat Grommet, 1m of 9mm Pipe,  
 1x Drill Template



**AUTO5 BASIC**

**AUTO5XL/UNIT**

**RRP £175.00**

- Includes:*  
 1 x Auto5 Lid,  
 1 x 1.2m sq Garden Tray,  
 1 x Round Blue Access Cover

**RRP = RECOMMENDED RETAIL PRICE**

**FOLLOW US FOR UPCOMING RELEASES**

**E: MAIL@AUTOPOT.CO.UK**

**🌐 AUTOPOT.CO.UK**

**📷 @AUTOPOT\_GLOBAL**



**AN EXPANDED RANGE OF FABRIC POTS FOR PLANTS OF ALL SIZES**

**INCLUDING 20 L POTS TO FIT OUR XL SYSTEM MODULES**

**35L, 50L & 139L POTS - FOR BIG, HEALTHY, FAST GROWING STOCK PLANTS**

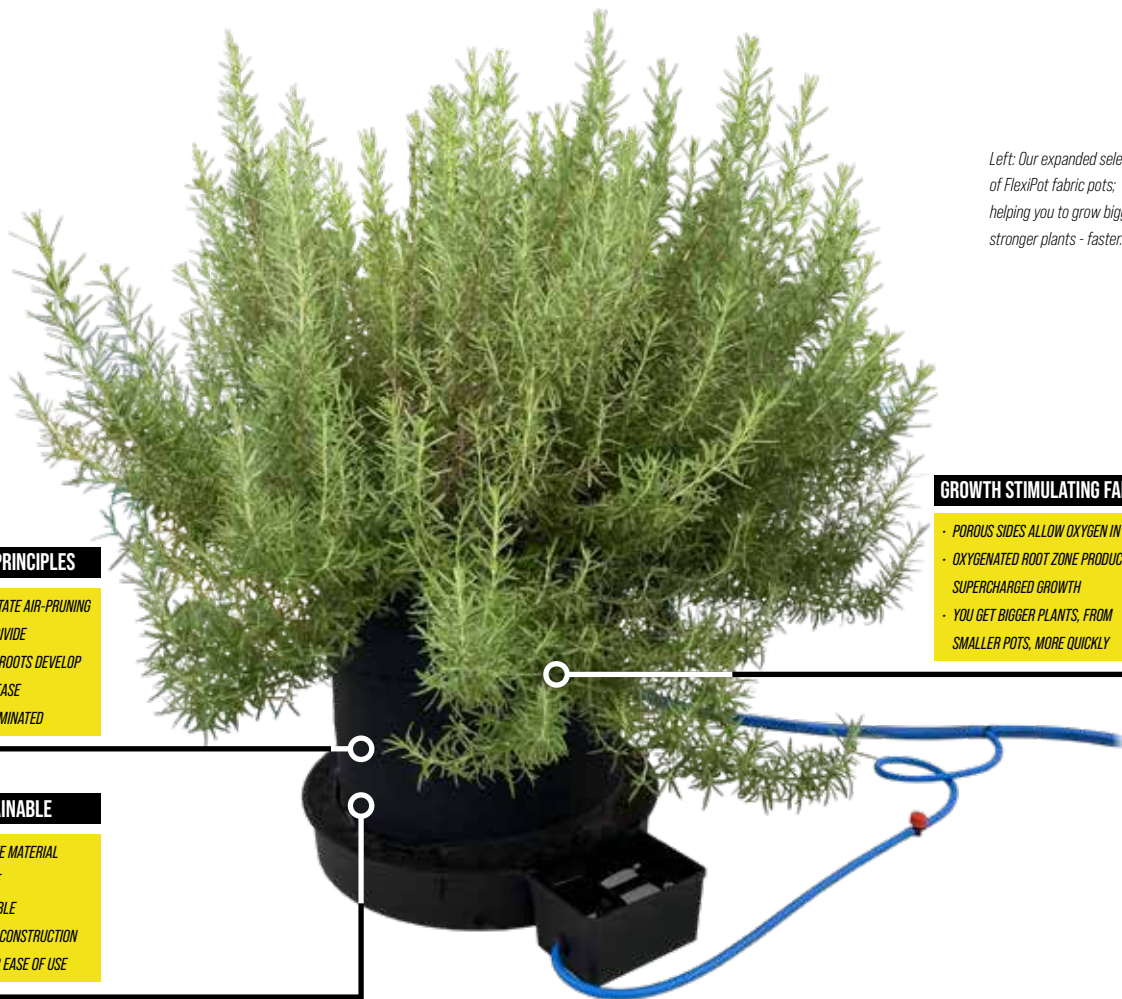

Left: Our expanded selection of FlexiPot fabric pots; helping you to grow bigger, stronger plants - faster.

**ROOT TRAINING PRINCIPLES**

- POROUS POTS FACILITATE AIR-PRUNING
- PRUNED ROOT TIPS DIVIDE
- SECONDARY FEEDER ROOTS DEVELOP
- UPTAKE RATES INCREASE
- ROOT CHASING IS ELIMINATED

**SAFE & SUSTAINABLE**

- BPA-FREE, LEAD-FREE MATERIAL
- MACHINE-WASHABLE
- EXTENSIVELY REUSABLE
- TOUGH, SUPPORTIVE CONSTRUCTION
- CARRY HANDLES FOR EASE OF USE

**GROWTH STIMULATING FABRIC**

- POROUS SIDES ALLOW OXYGEN IN
- OXYGENATED ROOT ZONE PRODUCES SUPERCHARGED GROWTH
- YOU GET BIGGER PLANTS, FROM SMALLER POTS, MORE QUICKLY

**20 L FLEXIPOT - APSMART/POT/5 RRP £6.80**

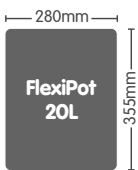

Suitable for:  
Auto3 & Auto9 - pages 34-35  
Garden trays - page 51  
XL module trays - page 57

**50 L FLEXIPOT - APSMART/POT/13 RRP £10.25**

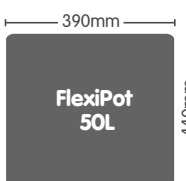

Suitable for:  
Garden trays - page 51  
XXL module trays - page 57

**35 L FLEXIPOT - APSMART/POT/9 RRP £8.80**

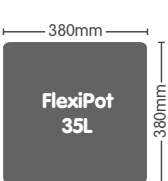

Suitable for:  
Garden trays - page 51  
XXL module trays - page 57

**139 L FLEXIPOT - APSMART/POT/37 RRP £14.50**

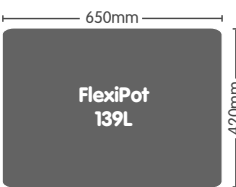

Suitable for:  
Garden trays - page 51

**RRP = RECOMMENDED RETAIL PRICE**

**FOR RESERVOIRS SEE PAGES 52-55**



**ONE TRAY, FIVE USES - AUTOMATIC WATERING AT ITS VERSATILE BEST**

**ACCOMMODATES GROW BAGS, SEED TRAYS, MICRO HERBS, POTS & PLANTERS**

**SUITABLE FOR ALL PLANT TYPES, AT ALL STAGES OF GROWTH**



*Tray2Grow with grow bags*

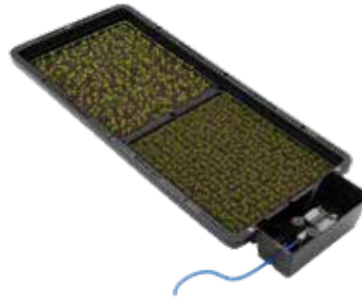

*Tray2Grow with microherbs*



*Tray2Grow with seed trays*



*Tray2Grow with pots*



*Tray2Grow with planters*

## **VERSATILITY**

Automatic watering at its versatile best, Tray2Grow offers gardeners a multitude of cultivation methods. From grow bags to seed trays, planters to coco slabs, pots to microherbs, Tray2Grow can be configured to suit every conceivable growth stage and every plant type.

## **INNOVATIVE IRRIGATION**

Equipped for every eventuality, Tray2Grow includes optional capillary spikes that can be fitted to the inside of the tray. These pierce the underside of a grow bag, allowing you to irrigate the substrate within. Guide holes in the tray are provided for bamboo canes, allowing you to easily trellis your plants.

## **ALLOTMENT SCALE**

With the spikes removed and capillary matting in place Tray2Grow can take up to four standard sized seed trays, two micro herb trays, two coco slabs, any number of bottom-perforated or bio pots, or our capacious 107.5 L / 23.5 gallon framed fabric planter.

**PART OF OUR NEW GARDEN CENTRE RANGE**

**WITH FULLY ILLUSTRATED RETAIL PACKAGING**

**E: MAIL@AUTOPOT.CO.UK**

**🌐 AUTOPOT.CO.UK**

**📷 @AUTOPOT\_GLOBAL**



**USE WITH CAPILLARY SPIKES TO IRRIGATE & FEED GROW BAGS**

**USE WITH CAPILLARY MATTING TO IRRIGATE & FEED POTS & TRAYS**

**TRAY2GROW PLANTER ALLOWS YOU TO GROW ROOT VEG ANYWHERE**



Above: Tray2Grow Complete includes capillary matting for use with pots, trays, and planters, plus capillary spikes for use with grow bags.

**« TRAY2GROW COMPLETE - AP/T2G**

**RRP £69.95**

**Includes:**

- 1x Tray2Grow Tray & Lid
- 1x AQUAvalve5
- 2x 9mm Grommet
- 1m of 9mm Pipe
- 16-9mm Click-Fit Filter
- 1x 9mm Golf Filter
- 1x 6mm Overflow Grommet
- 3x Circular Spirit Level
- 10x Capillary Spikes
- 1x Capillary Matting
- 1x Root Control Sheet
- 4x Seed Trays
- 1x Slug Repellent Copper Tape

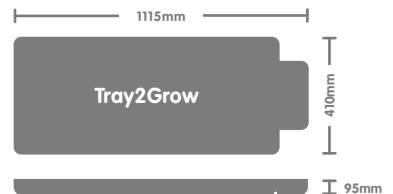

**TRAY2GROW - TRAY & LID**

**T2G/T-L**

**RRP £26.55**

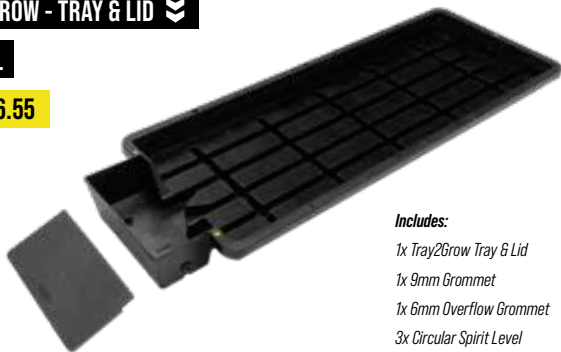

**Includes:**

- 1x Tray2Grow Tray & Lid
- 1x 9mm Grommet
- 1x 6mm Overflow Grommet
- 3x Circular Spirit Level

**TRAY2GROW PLANTER T2G/PLANTER**

**AVAILABLE SPRING 2023**

**RRP £39.95**



Grow root veg anywhere with Tray2Grow Planter - fully collapsible & washable

**TRAY2GROW ACCESSORIES & SPARES**



**« TRAY2GROW SPIKE & CAPILLARY**

**T2G/SPIKE/SET**

**RRP £1.20**

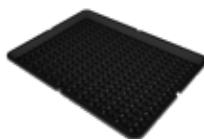

**« TRAY2GROW MICROHERB TRAY**

**T2G/MHTRAY**

**RRP £TBC**



**« TRAY2GROW ROOT CTRL SHEET**

**T2G/RCD/SHEET**

**RRP £7.95**



**« TRAY2GROW SPIKE ONLY**

**T2G/SPIKE**

**RRP £0.70**



**« TRAY2GROW SEED TRAY**

**T2G/SEEDTRAY**

**RRP £0.90**

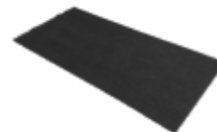

**« TRAY2GROW CAPILLARY MAT**

**T2G/CAPILLARY/MAT**

**RRP £12.40**

**RRP = RECOMMENDED RETAIL PRICE**

**FOR IN-EARTH IRRIGATION SEE PAGE 47**

# pot divider



**MULTIPLY THE PLANT OUTPUT OF EVERY MODULE WITH POTDIVIDER**

**USE IN THE PRE-VEG STAGE TO SUB-DIVIDE 8.5 L & 15 L POTS**

**EASY-TO-USE DESIGN ALLOWS PLANTS TO BE LIFTED OUT CLEANLY**

## POT DIVIDER – AP/POTDIVIDER

RRP £8.00



PotDivider 8.5 fits 8.5L pots as used in easy2grow and Auto8 systems



PotDivider 8.5 in easy2grow (top) and Auto8 (bottom) (modules not incl.)

## POT DIVIDER – AP15L/DIVIDER

RRP £11.45

**NOW AVAILABLE**

**15L POTDIVIDER**



PotDivider 15 fits 15L pots as used in 1Pot, easy2grow, and Auto8 systems



PotDivider 15 in a 1Pot module (module not incl.)

# strawberry topper



**PERFECT FOR GROWING STRAWBERRIES**

**DESIGNED TO FIT 8.5 L POTS - AS USED IN EASY2GROW**

**FOLIAGE GROWS UP, FRUITS HANG DOWN - EASY TO HARVEST**

## STRAWBERRY POT TOPPER

AP/POTTOPPER/8.5

RRP £3.00

*\*Production items in black only*



For 8.5 L pots & easy2grow modules see page 56 (pots & module not incl.)



Strawberry toppers sit directly on the rim of 8.5L pots



Fill pots with media and lay strawberry plants side-on



Top strawberry plants off with a little extra media

**RRP = RECOMMENDED RETAIL PRICE**

**FOLLOW US FOR UPCOMING RELEASES**

**E: MAIL@AUTOPOT.CO.UK**

**AUTOPOT.CO.UK**

**@AUTOPOT\_GLOBAL**



# PROPAGATION LIDS & SYSTEMS

A FULL RANGE OF PROPAGATION LIDS TO COVER ALL POT SIZES

LIDS HELP CREATE HUMIDITY IN PLANTS MICRO-ENVIRONMENT

HUMIDITY HELPS TO STIMULATE GROWTH AT A CRITICAL STAGE



8.5 / 15 L PROPAGATION LID - AP/PROPLID/SQ

RRP £6.50



Listing incl. lid only

For 8.5 / 15 L pots & easy2grow / 1Pot modules see pages 56-57  
8.5L / 15L Lid Dimensions: 265mm W x 260mm H

25 L PROPAGATION LID - AP/PROPLID/XL

RRP £8.50



Listing incl. lid only

For 25 L pots & 1Pot modules see pages 56-57 - 8.5L / 15L Propagation Lid Dimensions: 320mm W x 350mm H

4POT PRO SYSTEM - 4POT/PRO/5

RRP £128.00



4Pot Pro - Including propagation lids for essential humidity

## CONTENTS

1x 47 L reservoir & lid	1x 9mm golf filter	4x AQUAvalve5	4x marix disc
4x 1Pot tray & lid	4x 15 L pot	2x 9mm cross connector	4x root control disc
5x 9mm top hat grommet	4x propagation lids	4x 9mm tee connector	1x instruction sheet
	2x 9mm inline tap	4 m of 9mm pipe	

FLOORSPACE REQUIREMENTS: 1.2M x 1.2M EX. RES.

## CREATING THE RIGHT MICRO ENVIRONMENT WITH PROPAGATION LIDS

### 1. LID ON WITH VENTS CLOSED



Keep the vents closed to create a micro environment. The lid helps to generate the humidity that young plants crave.

### 2. OPENING THE VENTS



As your plant increases in size half open the vents to release some humidity and temperature.

### 3. HARDENING OFF



Fully open vents to harden off your plant. Once vents are fully opened leave for several days prior to removal of the lid

RRP = RECOMMENDED RETAIL PRICE

FOR ROOTZONE AERATION - SEE PAGES 48-49

@AUTOPOTUK

AUTOPOT.CO.UK

@AUTOPOTSYSYSTEMS



**CONTROL YOUR PLANTS ENVIRONMENT TO ACCELERATE ROOTING**

**WATER YOUNG PLANTS AND CUTTINGS WITH CONFIDENCE**

**INCREASE STRIKE RATES WITH LARGE VOLUMES OF YOUNG PLANTS**



### UNPARALLELED CHOICE

A cavernous 200mm lid height offers your plants more headroom than any other single piece propagator lid available, giving you greater choice as to when you transplant.

Four large, fully adjustable vents allow growers unparalleled scope to fine-tune an environment in which young plants can thrive.

### EFFICIENCY & FUNCTION

easy2Propagate ties together the proven growing technology of the AutoPot range.

Fitted with four 9mm piping ports, it is designed to accommodate an AQUAvalve for easy integration with low maintenance

AutoPot Watering Systems.

### GROWERS IN MIND

Use heat pads under the tray or propagation lights above it to warm the water in the tray and create humidity. We recommend a target temperature of 70-80°F / 25-30°C with minimum 80% humidity. For full propagation tips see pages 10-11

**E: MAIL@AUTOPOT.CO.UK**

**🌐 AUTOPOT.CO.UK**

**📷 @AUTOPOT\_GLOBAL**



**ALL EASY2PROPAGATE KITS AND LIDS FULLY BOXED**

**ULTRA-STRONG LID EASY TO SHIP SINGLE UNITS**

**AVAILABLE IN FOUR DIFFERENT KIT CONFIGURATIONS**

**EASY2PROPAGATE COMPLETE KIT - AP410/PROPKIT**

**RRP £165.00**



1x Clear easy2Propagate Lid with 4 x Fitted Vents, 1x 25 L FlexiTank, 1x 16mm-9mm Click-Fit Tank Adaptor & Filter, 1x AQUAvalve5, 1x AQUAvalve Cover, 1.5m of 9mm pipe, 1x 9mm Elbow Bar  
1x Garden Tray, 2x Coco Matting 580mm x 510mm x 30mm, 1x Root Control Sheet 1160mm x 510mm

**EASY2PROPAGATE EXTENSION KIT - AP410/PROPKIT/EXT**

**RRP £129.35**



1x Clear easy2Propagate Lid with 4 x Fitted Vents, 1x AQUAvalve5, 1x AQUAvalve Cover, 1x 16mm-9mm Tee Connector, 1x 9mm Tee Connector, 1x 9mm Elbow Bar, 1m of 9mm pipe, 1x Garden Tray, 2x Coco Matting 580mm x 510mm x 30mm, 1x Root Control Sheet 1160mm x 510mm

**EASY2PROPAGATE BASIC KIT - AP410/PROPKIT/UNIT**

**RRP £102.90**



1x Clear easy2Propagate Lid with 4 x Fitted Vents, 1x Garden Tray,  
2x Coco Matting 580mm x 510mm x 30mm, 1x Root Control Sheet 1160mm x 510mm

**EASY2PROPAGATE LID ONLY- AP410/PROPKIT/LID**

**RRP £46.20**



1x Clear easy2Propagate Lid with 4 x Fitted Vents  
(Fits Garden Tray - not included in Lid Only option)

**EASY2PROPAGATE DIMENSIONS**

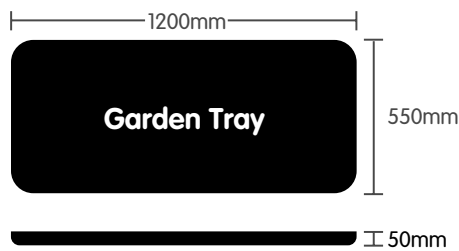
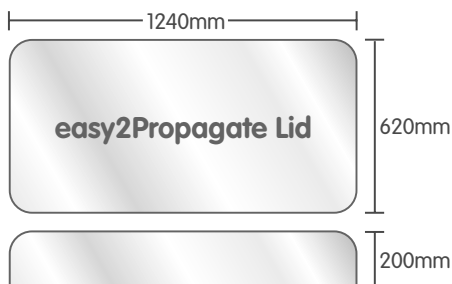

**RRP = RECOMMENDED RETAIL PRICE**

**SEE PAGES 10-11 FOR PROPAGATION TIPS**



**TURN ANY GARDEN TRAY INTO AN AUTOPOT WATERING SYSTEM**

**USE IN THE HOME, GREENHOUSE, CONSERVATORY OR ON A BALCONY**

**KEEPS PLANTS WATERED AND FED FOR WEEKS - POWER FREE!**

**EASY2GO - AP400**

**RRP £22.50**



*easy2GO - the endlessly adaptable kit that allows you to turn any flat tray into a watering system.*

**COCOMAT**

**THE IDEAL LOW-MAINTENANCE, NATURAL IRRIGATION SYSTEM**

**COCO FIBRES & NATURAL LATEX GENTLY WICK WATER & NUTRIENTS**

**FILL YOUR TRAY ONCE - COCOMAT WATERS FOR UP TO 10 DAYS**



*Fits all standard-sized propagation trays*

**COCOMAT BUNDLE- CCOCOPACK/1**

**RRP £11.35**

Includes: 1x Root Control Sheet,  
1x CocoMat 510mm x 300mm x 30mm

**COCOMAT - COCOMATting/58X51X3**

**RRP £12.50**

Includes:  
1x CocoMat 580mm x 510mm x 30mm



**1. PLACE COCOMAT AND ROOT CONTROL INTO A TRAY**

**2. FILL TRAY WITH WATER**

**3. PLACE SEED TRAY ON TOP AND GROW!**

**RRP = RECOMMENDED RETAIL PRICE**

**SEE PAGES 10-11 FOR PROPAGATION TIPS**

**E: MAIL@AUTOPOT.CO.UK**

**AUTOPOT.CO.UK**

**@AUTOPOT\_GLOBAL**



**FOR GROWING EVEN THE LARGEST OF PLANTS WITH AUTOPOT**

**NOW AVAILABLE AS A COMPLETE KIT - INCLUDING SKIRT, FITTINGS & TRAY**

**AVAILABLE FOR 60CM SQ AND 80-100CM SQ GARDEN TRAYS**



**PLANTSKIRT FOR 80-100CM TRAYS**

**AUTOSKIRT**

**RRP £19.99**

*Includes:*

1x PlantSkirt for 80-100cm Trays

Fits a tray of 80-100cm sq.

Fits a pot with a max diameter of 70cm

Pot, tray and substrate not included



**PLANTSKIRT FOR 60CM TRAYS**

**AUTOSKIRT/SMALL**

**RRP £18.80**

*Includes:*

1x PlantSkirt for 60cm Trays

Fits a tray of 60cm sq.

Fits a pot with a max diameter of 40cm

Pot, tray and substrate not included

With PlantSkirt the heat and light that would otherwise cause nutrient solution to evaporate is instead reflected back onto the plant - promoting growth

**PLANTSKIRT COMPLETE 60 - AUTOSKIRT/60X60KIT/96**

**RRP £58.35**



*Includes:*

1x PlantSkirt Small, 1x 35L fabric FlexiPot, 1x 60cm sq Garden Tray, 1x AQUAvalve PotSock, 1x AQUAvalve PotSock Plate, 1x AQUAvalve5, 1x AQUAvalve Cover, 1m of 9mm pipe, 1x 9mm Elbow Bar, 1x 16mm-9mm Tee Connector, 1x 16-9mm Cross Connector, 1x 9mm Tee Connector

**PLANTSKIRT COMPLETE 80 - AUTOSKIRT/80X80KIT/376**

**RRP £75.45**



*Includes:*

1x PlantSkirt, 1x 139L fabric FlexiPot, 1x 80cm sq Garden Tray, 1x AQUAvalve PotSock, 1x AQUAvalve PotSock Plate, 1x AQUAvalve5, 1x AQUAvalve Cover, 1m of 9mm pipe, 1x 9mm Elbow Bar, 1x 16mm-9mm Tee Connector, 1x 16-9mm Cross Connector, 1x 9mm Tee Connector

**PLANTSKIRT COMPLETE 100 - AUTOSKIRT/100X100KIT/376**

**RRP £85.95**



*Includes:*

1x PlantSkirt, 1x 139L fabric FlexiPot, 1x 100cm sq Garden Tray, 1x AQUAvalve PotSock, 1x AQUAvalve PotSock Plate, 1x AQUAvalve5, 1x AQUAvalve Cover, 1m of 9mm pipe, 1x 9mm Elbow Bar, 1x 16mm-9mm Tee Connector, 1x 16-9mm Cross Connector, 1x 9mm Tee Connector

**SETTING UP WITH PLANTSKIRT**

**SEE PAGE 51 FOR GARDEN TRAYS**



**1**

Position pot centrally in tray.  
Fill pot with medium and put up plants.  
Water through pot and allow to drain.



**2**

Place AQUAvalve PotSock and plate onto the tray.  
Fit pipe and Elbow Bar to AQUAvalve and place into the AQUAvalve PotSock.  
Connect the AQUAvalve up to your reservoir.



**3**

The PlantSkirt is secured around the middle of the pot and the outer rim of the tray.  
Secure in place with the PlantSkirt's drawstrings.



**4**

Once the drawstrings are pulled tight the PlantSkirt provides an effective seal preventing light and debris from entering the tray.

**RRP = RECOMMENDED RETAIL PRICE**

**FOR FABRIC FLEXIPOTS SEE PAGE 37**



**GROW FREE FROM SUBSTRATE WITH AUTOPOT**

**GIVE PLANTS DIRECT ROOT ACCESS TO NUTRIENT RICH WATER**

**ENCOURAGE FASTER, STRONGER ROOT DEVELOPMENT**

**AQUAPLATE SQUARE - AQUAPLATE/KIT/SQ**

**RRP £12.50**

Includes: 1x AQUAplate Square, 5x Mesh Pots, 5x Neoprene Collars, 5x Foam Pads, 1x PotSock Square

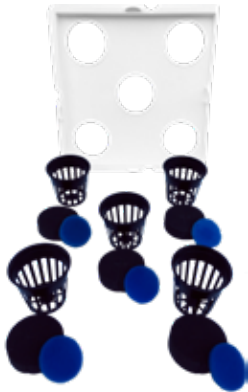

AQUAplate Square fits easy2grow trays  
See page 57



AQUAplate Square fits 1Pot trays  
See page 57

**AQUAPLATE CIRCLE - AQUAPLATE/KIT/CIR**

**RRP £13.50**

Includes: 1x AQUAplate Circle, 5x Mesh Pots, 5x Neoprene Collars, 5x Foam Pads, 1x PotSock Round



AQUAplate Circle fits 1Pot XL trays  
See page 57

**CONVERT YOUR AUTOPOT TRAY TO AQUAPLATE IN MINUTES!**

**1**

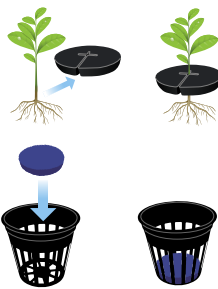

Slot your plant into the black neoprene collar.  
Seat the blue foam pad in the base of the mesh pot

**2**



Fit your collared plant into the top of the mesh pot.  
Rooted plant plugs may also be used.

**3**

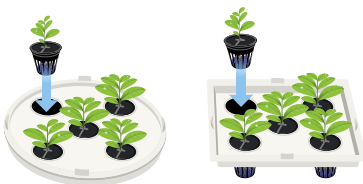

Place mesh pots into the AQUAplate.

**4**

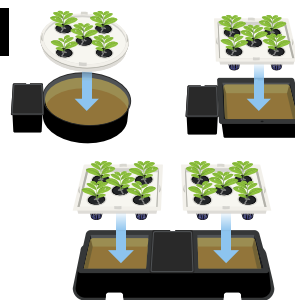

Position tray (supplied separately) on a level surface. Insert PotSock copper face up.  
Place the AQUAplate in your tray. Connect and switch on system.

**AQUAPLATE ACCESSORIES**



MESH POT FOR AQUAPLATE  
AQUAPLATE/TEKUM6B  
RRP £0.10



BLUE FOAM DISC FOR AQUAPLATE  
AQUAPLATE/FT-T60PPI  
RRP £0.30



NEOPRENE COLLAR FOR AQUAPLATE  
AQUAPLATE/FOAM50MM  
RRP £0.55

**RRP = RECOMMENDED RETAIL PRICE**

**SEE PAGE 57 FOR MODULE TRAYS**

**E: MAIL@AUTOPOT.CO.UK**

**AUTOPOT.CO.UK**

**@AUTOPOT\_GLOBAL**



**IDEAL FOR RAISED BEDS, LARGE PLANTERS, AND GROW BAGS**

**PLANTS ARE WATERED FOR DAYS OR WEEKS AT A TIME**

**CAPILLARY MATTING DISTRIBUTES WATER & FEED UNDER THE SOIL**

**AQUABOX STRAIGHT - PLANTERS & NARROW BEDS**

**AQUABOX STRAIGHT - AQUABOX/1 RRP £23.80**

Includes: 1x AQUAbox Straight, 1x AQUAvalve5, 1x Circular spirit level, 1x 9mm top hat grommet, 1.2m of capillary matting, 2m of 9mm pipe, 1x 16mm-9mm Click-Fit adapter & filter

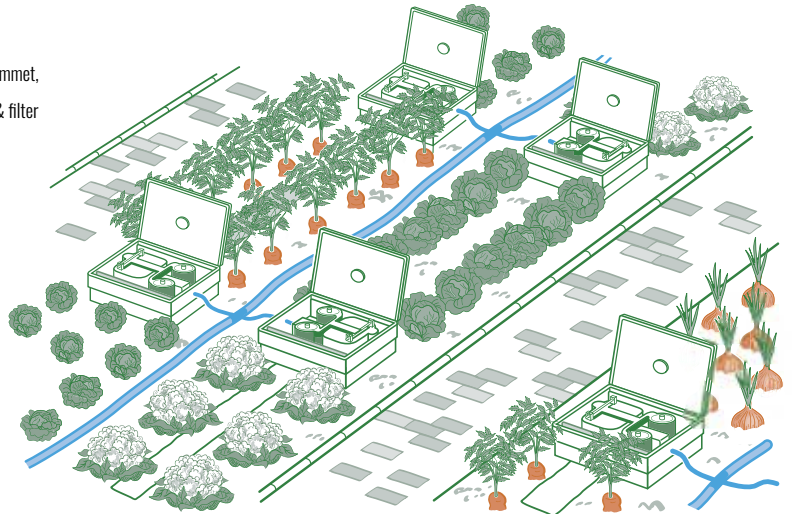

**AQUABOX SPYDER - WIDE RAISED BEDS & ALLOTMENTS**

**AQUABOX SPYDER - AQUABOX/2 RRP £31.10**

Includes: 1x AQUAbox Spyder, 1x AQUAvalve5, 1x Circular spirit level, 1x 9mm top hat grommet, 2m of 9mm pipe, 6m of capillary matting, 1x 16mm-9mm Click-Fit adapter & filter

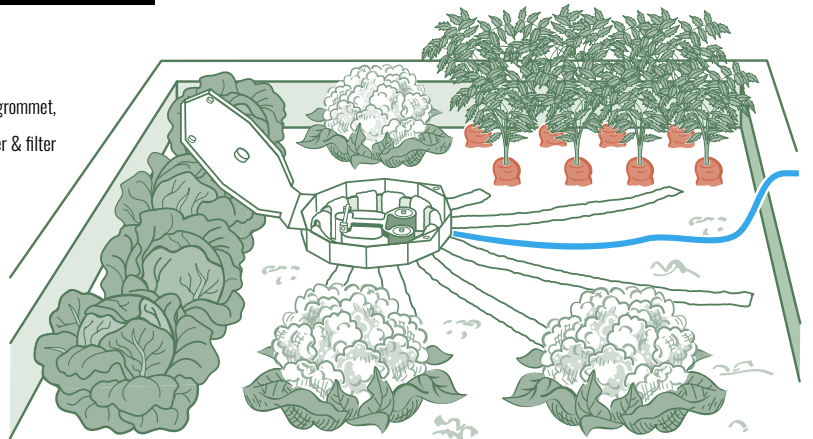
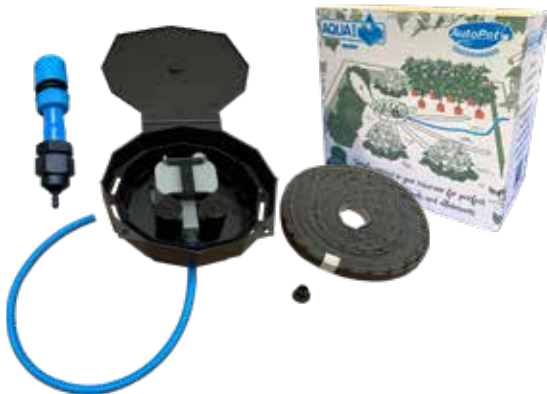

**AQUABOX ACCESSORIES**



**AQUABOX STRAIGHT REPLACEMENT MATTING 1200MM x 45MM**  
**ABQ/STRAIGHT**  
**RRP £4.15**



**AQUABOX SPYDER REPLACEMENT MATTING 6000MM x 15MM**  
**ABQ/SPYDER**  
**RRP £5.90**

**RRP = RECOMMENDED RETAIL PRICE**

**SEE OUR YOUTUBE CHANNEL FOR VIDEOS**

**@AUTOPOTUK**

**AUTOPOT.CO.UK**

**@AUTOPOTSYSTEMS**



**BOOST GROWTH & YIELDS BY INCREASING OXYGEN CONTENT IN THE POT**

**GET A HEALTHIER ROOT ZONE & GREATER NUTRIENT UPTAKE**

**TAKES LESS THAN 30 SECONDS TO ASSEMBLE**

**AIRDOME COMPLETE - AIRDOME/1**

**RRP £5.60**

Includes: 1x AirDome body, 6mm straight connector, 1x 6mm cross connector, 4x pieces of blue bubble pipe, 1m length of 6mm pipe, 1x full instructions



**AIRDOME BODY ONLY**

AD/A

**RRP £1.70**



**6MM PIPE (1M LENGTH)**

PF100/1

**RRP £0.80**



**6MM PIPE (50M LENGTH)**

PF100/6/1

**RRP £37.80**



**BUBBLE PIPE FOR AIRDOME (52MM LENGTH)**

AD/PIPE

**RRP £0.30**



**USING AIRDOME WITH AUTOPOT & AIR PUMPS**

If using AirDomes with large systems, consider using larger pumps such as Power Pumps 4, 6, and 10 - marked ● these pumps allow you to connect 16mm pipe (standard hosepipe). Mirror your water supply and reduce the pipe to 6mm at each AirDome connection, using AutoPot fittings. Never blow cold air into the root zone, only warm air (18-21° C is ideal).

**AIR PUMP SINGLE OUTLET - LD2-AIRPUMP**

**RRP £7.25**

**FLOW:** 1.6 LITRES PER MINUTE  
**VOLTAGE:** 230V 50HZ  
**POWER CONSUMPTION:** 2W  
**PRESSURE:** 0.15 BAR  
**DIMENSIONS:** 110 L X 68 W X 63 H (MM)  
**CAPABLE OF SUPPLYING:** 2 X AIRDOMES



**AIR PUMP TWIN OUTLET - LD4-AIRPUMP**

**RRP £13.00**

**FLOW:** 2X 2.0 LITRES PER MINUTE  
**VOLTAGE:** 230V 50HZ  
**POWER CONSUMPTION:** 4W  
**PRESSURE:** 0.20 BAR  
**DIMENSIONS:** 156 L X 95 W X 75 H (MM)  
**CAPABLE OF SUPPLYING:** 4 X AIRDOMES



**AIR PUMP QUAD OUTLET - LD10-AIRPUMP**

**RRP £18.50**

**FLOW:** 4X 2.25 LITRES PER MINUTE  
**VOLTAGE:** 230V 50HZ  
**POWER CONSUMPTION:** 8W  
**PRESSURE:** 0.20 BAR  
**DIMENSIONS:** 188 L X 120 W X 100 H (MM)  
**CAPABLE OF SUPPLYING:** 8 X AIRDOMES



**POWER AIR PUMP 4 OUTLET - V20-4OUTLET**

**RRP £46.80**

**FLOW:** 4X 5 LITRES PER MINUTE  
**VOLTAGE:** 230V 50HZ  
**POWER CONSUMPTION:** 15W  
**PRESSURE:** 0.20 BAR  
**DIMENSIONS:** 230 L X 185 W X 180 H (MM)  
**CAPABLE OF SUPPLYING:** 20 X AIRDOMES



● OPTIONAL 16MM CONNECTION

**POWER AIR PUMP 6 OUTLET - V30-6OUTLET**

**RRP £60.00**

**FLOW:** 6X 5 LITRES PER MINUTE  
**VOLTAGE:** 230V 50HZ  
**POWER CONSUMPTION:** 25W  
**PRESSURE:** 0.20 BAR  
**DIMENSIONS:** 245 L X 202 W X 205 H (MM)  
**CAPABLE OF SUPPLYING:** 30 X AIRDOMES



● OPTIONAL 16MM CONNECTION

**POWER AIR PUMP 10 OUTLET - V60-10OUTLET**

**RRP £80.00**

**FLOW:** 60 LITRES PER MINUTE  
**VOLTAGE:** 230V 50HZ - OPTION 110V  
**POWER CONSUMPTION:** 35W  
**PRESSURE:** 0.35 BAR  
**DIMENSIONS:** 270 L X 242 W X 210 H (MM)  
**CAPABLE OF SUPPLYING:** 60 X AIRDOMES



● OPTIONAL 16MM CONNECTION

**RRP = RECOMMENDED RETAIL PRICE**

**SEE PAGE 6 FOR AIRDOME ADVICE**

**E: MAIL@AUTOPOT.CO.UK**

**AUTOPOT.CO.UK**

**@AUTOPOT\_GLOBAL**





**OPTIMISES ROOT ZONE DRAINAGE IN AUTOPOT WATERING SYSTEMS**

**REMOVES THE NEED FOR A PEBBLE LAYER IN THE BASE OF YOUR POT**

**DESIGNED FOR EASY, OPTIONAL INTEGRATION WITH AIRDOME**

**AIRBASE SQUARE - AIRBASE/SQUARE**

**RRP £7.49**



**AIRBASE ROUND - AIRBASE/ROUND**

**RRP £7.99**



**BETTER DRAINAGE, BETTER GROWTH**

Give your plants a lift with AirBase. This handy plate fits into the bottom of your pot and allows you to sidestep the use of a pebble layer for drainage. A beautifully simple and effective innovation, AirBase is fabricated from tough ABS plastic making it highly durable and thus extensively reusable.

- AirBase Square fits our 8.5L and 15L plastic pots
- AirBase Round fits our 25L plastic pots & 20L fabric pots

**AIRDOME COMPATIBLE - AERATE YOUR ROOT ZONE FOR SUPERCHARGED GROWTH**



**AIRBASE SQUARE WITH AIRDOME** ⬆️



**AIRBASE ROUND WITH AIRDOME** ⬆️

AirBase features a pop-out centre-section allowing for easy, optional AirDome integration. The AirDome sits beneath the AirBase and pumps oxygen into your root zone via bubble pipe. This aeration helps roots expand more quickly and stimulates the development of a highly absorptive root structure for improved nutrient uptake. The aeration also helps to maintain the condition of your substrate, for a healthy, productive, disease-free root zone.



**AIRBASE SQUARE WITH AIRDOME IN 1POT** ⬆️



**AIRBASE ROUND WITH AIRDOME IN 1POT XL** ⬆️



**AIRBASE ROUND WITH AIRDOME IN XL FLEXIPOT** ⬆️

*\*Blue AirDomes for illustrative purposes only - production AirDomes now in black*

**RRP = RECOMMENDED RETAIL PRICE**

**SEE PAGES 10-11 FOR PROPAGATION TIPS**

**@AUTOPOTUK**

**AUTOPOT.CO.UK**

**@AUTOPOTSYSTEMS**

# CO<sub>2</sub> MOTHERNATURE GENERATOR 2

THE MOST PRODUCTIVE, EFFICIENT, EASY-TO-USE CO<sub>2</sub> INPUT ON THE MARKET

PROVIDES AN ENORMOUS BOOST TO CARBON DIOXIDE-HUNGRY PLANTS

INCREASES CO<sub>2</sub> LEVELS FROM 400PPM TO 800PPM

## AVAILABLE NOW! CO<sub>2</sub> REFILLS



- REGENERATE YOUR CO<sub>2</sub> SUPPLY
- 33% CHEAPER THAN A NEW UNIT
- 5L & 10L DRY MIX PACKS OUT NOW!

## FOR MAXIMUM EFFECT

- PLACE YOUR CO<sub>2</sub> GENERATOR LOW
- ENSURE IT IS BENEATH YOUR PLANTS
- AS CO<sub>2</sub> WARMS IT RISES INTO CANOPY

## SYNCH WITH YOUR LIGHTING

- PLUG YOUR PUMP INTO YOUR LIGHTING TIMER / RELAY & PULSE HOURLY
- OPERATE DURING 'LIGHTS ON' ONLY



◀◀ CO<sub>2</sub> GENERATOR 10L PS - CB - 002

RRP £110.00

JUST £0.61 PER DAY!\*

For areas up to 2.4m x 2.4m. Incl. single outlet pump & 13A plug. \*Based on 6 month lifespan

## WHAT YOUR PLANTS WANT

- CO<sub>2</sub> STIMULATES VIGOROUS GROWTH
- PROVEN TO INCREASE PRODUCTIVITY
- SPECIALLY FORMULATED MANURE
- ACTIVATED BY NATURAL BACTERIA

## USER-FRIENDLY DRY MIX

- 100% ODOUR-FREE STORAGE
- 5,000 YEAR SHELF LIFE
- SIMPLY ACTIVATED WITH HOT WATER
- USED MIX SAFELY & PRODUCTIVELY
- DISPOSED OF AS FERTILISER



◀◀ CO<sub>2</sub> GENERATOR 5L

PS - CB - 001

RRP £70.00

JUST £0.39 PER DAY!\*



◀◀ 10L CO<sub>2</sub> GEN. REFILL

PS - CB - 006

RRP £75.00

JUST £0.42 PER DAY!\*



◀◀ 5L CO<sub>2</sub> GEN. REFILL

PS - CB - 005

RRP £50.00

JUST £0.28 PER DAY!\*

For areas up to 1.2m x 1.2m. Incl. single outlet pump & 13A plug  
\*Based on 6 month lifespan

For 10L Generators - areas up to 2.4m x 2.4m.  
\*Based on 6 month lifespan - cost based on refill only

For 5L Generators - areas up to 1.2m x 1.2m.  
\*Based on 6 month lifespan - cost based on refill only

## Seeing is believing!

Use our Handheld CO<sub>2</sub> Detector to check your levels or show your customers CO<sub>2</sub> Generator in action!



◀◀ CO<sub>2</sub> DETECTOR

ABH - 102

RRP £59.95

As CO<sub>2</sub> levels of over 1100ppm have no extra effect on plant growth, you only stand to waste your inputs by blindly ramping up concentrations. Armed with readouts from our CO<sub>2</sub> Detector you can adjust your inputs to the 1100ppm 'sweet spot' adhered to by experienced growers.

RRP = RECOMMENDED RETAIL PRICE

REGENERATE YOUR SUPPLY WITH CO<sub>2</sub> REFILLS

E: MAIL@AUTOPOT.CO.UK

AUTOPOT.CO.UK

@AUTOPOT\_GLOBAL

# GARDEN TRAYS



57cm (22.5") Long 38.5cm (15.25") Wide 5cm (2") High

**STANDARD GARDEN TRAY - G16B**

RRP £6.30



100cm (39.5") Long, 40cm (16") Wide, 5cm (2") High

**GROW BAG TRAY - G182B**

RRP £6.30



79cm (31") Long 40cm (16") Wide 5cm (2") High

**MAXI TRAY - G74B**

RRP £8.60



79cm (31") Long 40cm (16") Wide 4cm (1.5") High

**DEEP RIDGE TRAY - G83B**

RRP £8.65



59cm (23") Long, 59cm (23") Wide, 7cm (3") High

**SQUARE GARDEN TRAY - G45B**

RRP £11.60



117cm (46") Long, 40cm (16") Wide, 5cm (2") High

**JUMBO TRAY - G15B**

RRP £12.30



110cm (43") Long 55cm (21.5") Wide 5cm (2") High

**GIANT TRAY - G81B**

RRP £16.85



120cm (47") Long, 55cm (21.5") Wide, 5cm (2") High

**GIANT PLUS TRAY - G82B**

RRP £18.10



100cm (39.5") Long, 55cm (21.5") Wide, 15cm (6") High

**TITAN TRAY - G95B**

RRP £18.90



80cm (31.5") Long, 80cm (31.5") Wide, 12cm (5") High

**80CM SQUARE TRAY - G172B**

RRP £21.00



100cm (39.5") Long, 100cm (39.5") Wide, 12cm (5") High

**1M SQUARE TRAY - G112B**

RRP £31.50



120cm (47") Long, 120cm (47") Wide, 12cm (5") High

**1.2M SQUARE TRAY - G127B**

RRP £42.00

Propagators - substrates and plants not included - illustrative purposes only



23cm (9") Long 17cm (6.5") Wide 18cm (7") High

**SMALL HIGH DOME PROPAGATOR - G20**

RRP £6.30

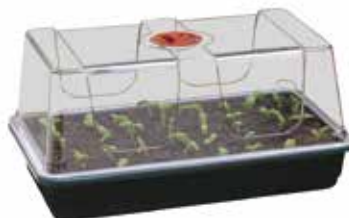

37.5cm (15") Long 23cm (9") Wide 18cm (7") High

**LARGE HIGH DOME PROPAGATOR - G19**

RRP £9.35



58cm (23") Long, 40.5cm (16") Wide, 22.5cm (9") High

**XL DOME PROPAGATOR - G155B**

RRP £23.65

**RRP = RECOMMENDED RETAIL PRICE**

**SEE PAGES 10-11 FOR PROPAGATION TIPS**



**THE BEST SELLING FLEXIBLE RESERVOIR IN THE WORLD**

**A REVOLUTIONARY APPROACH TO WATER STORAGE**

**A FLEXITANK FOR VIRTUALLY ANY GROWING SPACE - BIG OR SMALL**



### **SIMPLICITY ITSELF**

FlexiTank revolutionises water storage, it is everything you need in one compact box. These lightweight and durable reservoirs require no tools for assembly, reduce storage and shipping costs and take just minutes to assemble.

### **BUILT TO LAST**

FlexiTanks incorporate a level of design and build quality that far outstrips that of our competitors. Thicker skins, higher grade seals and stronger fittings make FlexiTank the only collapsible reservoirs recommended for use with AutoPot Watering Systems.

### **FOR ANY SPACE**

Available in seven sizes, from 25 L to 1000 L, FlexiTanks allow growers to set up in hitherto unexplored spaces. The 25 and 50 L FlexiTanks mean you can fit a reservoir virtually anywhere. These additions to the FlexiTank range mean that almost no space is too small for a system.

**E: MAIL@AUTOPOT.CO.UK**

**🌐 AUTOPOT.CO.UK**

**📷 @AUTOPOT\_GLOBAL**



**FULLY COLLAPSIBLE WITH TOOL-FREE ASSEMBLY**

**LIGHTWEIGHT & DURABLE WITH 1 YEAR MANUFACTURERS WARRANTY**

**INSTALL ANYWHERE, EASY TO SHIP AND STORE**

**25L FLEXITANK - APFLEXITANK/25**

**RRP £27.80**



**50L FLEXITANK - APFLEXITANK/50**

**RRP £34.20**



**100L FLEXITANK - APFLEXITANK/100**

**RRP £48.10**



**225L FLEXITANK - APFLEXITANK/225**

**RRP £64.10**



**400L FLEXITANK - APFLEXITANK/400**

**RRP £116.50**

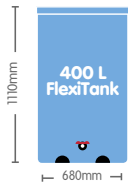

**750L FLEXITANK - APFLEXITANK/750**

**RRP £203.15**

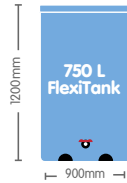

**1000L FLEXITANK - APFLEXITANK/1000**

**RRP £267.30**

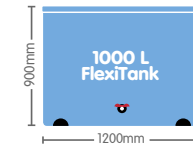

**PRO CLICK-FIT ADAPTOR & FILTER - AP217/PRO**

**RRP £16.45**



**16MM PROFILTER - PROFILTER1**

**RRP £13.60**



*Requires 16mm hose connector*

**16MM CLICK-FIT ADAPTOR & FILTER - AP217/16**

**RRP £11.75**



**16MM-9MM CLICK-FIT FILTER - AP217/9**

**RRP £6.85**



**HOSE CONNECTOR 16MM - HOSE CONNECTOR 1/2"**

**RRP £3.10**



**FLEXITANK FITTING CAP - APFLEXI/CAP**

**RRP £2.80**



**FLEXITANK TAP - FLEXITAP/1**

**RRP £5.60**



**FLEXITANK FITTING CLICK-FIT - APFLEXI/CLICK**

**RRP £2.80**



**COMING SOON! - FLEXITANK FOR RECIRCULATORS - TAPLESS RESERVOIRS AVAILABLE SPRING 2023**

**100L TAPLESS FLEXITANK - NTFLEXITANK100**

**RRP £48.10**



**250L TAPLESS FLEXITANK - NTFLEXITANK250**

**RRP £71.25**



**400L TAPLESS FLEXITANK - NTFLEXITANK400**

**RWP £116.50**



**750L TAPLESS FLEXITANK - NTFLEXITANK750**

**RWP £203.15**



**RRP = RECOMMENDED RETAIL PRICE**

**SEE PAGE 12 FOR RESERVOIR & WATER TIPS**



REFLECTIVE AND LIGHT-TIGHT; PERFECT FOR BRIGHT, HIGH TEMP SITUATIONS

CONCEALED SUPPORTS AND INTERNAL CAPACITY MARKINGS

ULTRA-STRONG, ANTI-TIP DESIGN



### IN EXTREMIS

The Revolution Refined: FlexiTank Pro is the perfect solution for water storage in bright, high temperature situations. The reflective and light-tight skin can help to keep water and nutrient solution at a stable temperature in extreme climates.

### PRACTICAL AND STYLISH

FlexiTank Pro's skin beautifully disguises an extremely rugged, fully collapsible design within. Concealed supports and internal capacity markings add neat edges to the proven, ultra-strong, ultra-practical FlexiTank design.

### UPGRADE NOW

FlexiTank and FlexiTank Pro utilise the same accessories and fittings for easy integration with AutoPot Watering Systems. All AutoPot Watering Systems are available with the option to upgrade to a FlexiTank Pro reservoir. Ask your stockist for further details.

E: MAIL@AUTOPOT.CO.UK

🌐 AUTOPOT.CO.UK

📷 @AUTOPOT\_GLOBAL



**ONE YEAR'S MANUFACTURERS WARRANTY**

**COMPLETE WITH ATTRACTIVE RETAIL PACKAGING**

**AVAILABLE AS AN UPGRADE ON ALL AUTOPOT WATERING SYSTEMS**

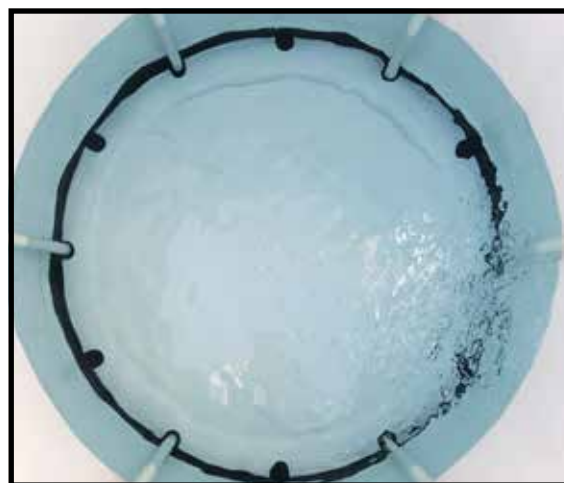
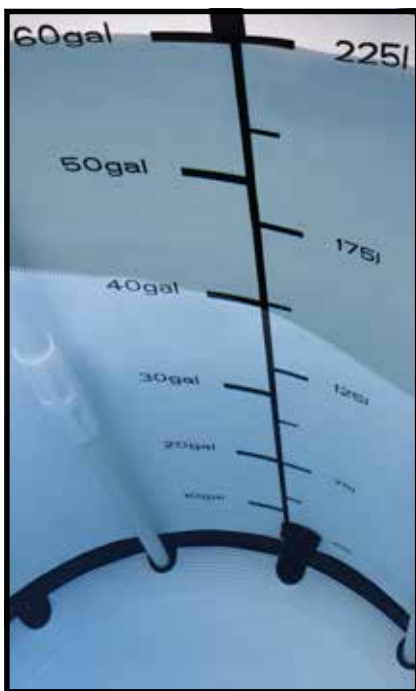

**100 L FLEXITANK PRO - PROFLEXITANK/100**

**RRP £85.15**



**225 L FLEXITANK PRO - PROFLEXITANK/225**

**RRP £128.70**



**400 L FLEXITANK PRO - PROFLEXITANK/400**

**RRP £188.10**



**RRP = RECOMMENDED RETAIL PRICE**

**SEE PAGE 12 FOR RESERVOIR & WATER TIPS**

# MODULES & PACKS

**RRP = RECOMMENDED RETAIL PRICE**

**XXL MODULE - APXXL/35L/MODULE**

RRP £39.95 **WITH 50L POT\* RRP £39.95**



- Includes:**  
 1x XXL tray, lid & blanking grommet  
 1x 9mm top hat grommet  
 1x 35 L or\* 50 L fabric FlexiPot,  
 1x adaptive collar (XXL35 only)  
 1x AQUAvalve5,  
 1x 1 m of 9mm pipe,  
 1x root control PotSock,  
 1x 9mm tee connector,  
 1x 16-9mm tee connector,  
 1x 16-9mm cross connector,  
 1x full instructions

**1POTXL MODULE - AP300/XL**

RRP £33.95



- Includes:**  
 1x XL tray and lid  
 1x 9mm top hat grommet  
 1x 25 L pot,  
 1x AQUAvalve5,  
 1x 1 m of 9mm pipe,  
 1x root control disc,  
 1x 9mm tee connector,  
 1x 16-9mm tee connector,  
 1x 16-9mm cross connector,  
 1x full instructions

**FlexiPot MODULE - APSMART/MODULE**

RRP £33.95



- Includes:**  
 1x XL tray and lid  
 1x 9mm top hat grommet  
 1x 20 L fabric FlexiPot,  
 1x AQUAvalve5,  
 1x 1 m of 9mm pipe,  
 1x PotSock Round,  
 1x 9mm tee connector,  
 1x 16-9mm tee connector,  
 1x 16-9mm cross connector,  
 1x full instructions

**1POT MODULE - AP200/SQ**

RRP £27.50



- Includes:**  
 1x 1Pot tray, lid & 9mm top hat grommet  
 1x 15 L pot,  
 1x AQUAvalve5,  
 1x 1m of 9mm pipe,  
 1x marix disc,  
 1x root control disc,  
 1x 9mm tee connector,  
 1x 16-9mm tee connector,  
 1x 16-9mm cross connector,  
 1x full instructions

**EASY2GROW MODULE - AP204/SQ**

RRP £32.85 **WITH 15L POTS RRP £34.05**



- Includes:**  
 1x easy2grow tray and lid,  
 2x 8.5 L pot,  
 1x AQUAvalve5,  
 1x 1 m of 9mm pipe,  
 2x marix disc,  
 2x PotSock Square,  
 1x 9mm tee connector,  
 1x 16-9mm tee connector,  
 1x 16-9mm cross connector,  
 1x full instructions

**1POT MODULE ACC. PACK - AQUAVALVE 5 - AP200/AQ5/PACK**

RRP £16.00



- Incl.** 1x AQUAvalve5, 1m of 9mm pipe, 1x marix disc, 1x root ctrl disc, 1x 9mm tee, 1x 16-9mm tee, 1x 16-9mm cross, 1x 9mm top hat grommet, 1x instructions

**1POT XL MODULE ACC. PACK - AQUAVALVE 5 - AP300/AQ5/PACK**

RRP £16.00



- Includes:** 1x AQUAvalve5, 1m of 9mm pipe, 1x root ctrl disc, 1x 9mm tee, 1x 16-9mm tee, 1x 16-9mm cross, 1x 9mm top hat grommet, 1x instructions

**EASY2GROW EXT. ACC. PACK - AQUAVALVE 5 - AP204/AQ5/PACK**

RRP £16.50



- Includes:** 1x AQUAvalve5, 1m of 9mm pipe, 1x 9mm tee, 1x 16-9mm tee, 1x 16-9mm cross, 2x marix discs, 2x PotSock Squares, 1x full instructions

**EASY2GROW KIT ACC. PACK - AQUAVALVE 5 - AP201/AQ5/PACK**

RRP £18.70



- Includes:** 1x AQUAvalve5, 2x PotSock Square, 2x marix disc, 1.5m of 9mm pipe, 1x 9mm in-line tap, 1x 9mm golf filter, 1x 9mm grommet, 1x full instructions

**FLEXIPOT MODULE ACC. PACK - AQUAVALVE 5 - APSMART/AQ5/PACK**

RRP £17.45



- Includes:** 1x AQUAvalve5, 1m of 9mm pipe, 1x PotSock Round, 1x 9mm tee, 1x 16-9mm tee, 1x 16-9mm cross, 1x 9mm top hat grommet 1x instructions

**FLEXIPOT MODULE ACC. PACK - AQUAVALVE 5 - APSMART/AQ5/MDPACK**

RRP £22.00



- Incl.** 1x 20L FlexiPot, 1x AQUAvalve5, 1m of 9mm pipe, 1x PotSock Round, 1x 9mm tee, 1x 16-9mm tee, 1x 16-9mm cross, 1x 9mm top hat grommet, 1x instructions

**XXL35 MODULE ACC. PACK - AQUAVALVE 5 - APXXL/35L/PACK**

RRP £25.75

**INCL. POT**



- Includes:**  
 1x AQUAvalve5      1x 1m of 9mm Pipe  
 1x 35L Fabric FlexiPot      1x 16-9mm cross  
 1x PotSock for 35L Pot      1x 16-9mm tee  
 1x 9mm top hat grommet      1x 9mm tee  
 1x 6mm blanking grommet      1x instructions

**XXL50 MODULE ACC. PACK - AQUAVALVE 5 - APXXL/50L/PACK**

RRP £29.70

**INCL. POT**



- Includes:**  
 1x AQUAvalve5      1x 1m of 9mm Pipe  
 1x 50L Fabric FlexiPot      1x 16-9mm cross  
 1x PotSock for 50L Pot      1x 16-9mm tee  
 1x 9mm top hat grommet      1x 9mm tee  
 1x 6mm blanking grommet      1x instructions

**MODULE PACKS & SPARES FOR 6MM AQUAVALVE SYSTEMS AVAILABLE ON REQUEST - CONTACT YOUR REP FOR DETAILS**



# POTS & TRAYS

**RRP = RECOMMENDED RETAIL PRICE**



INCL. 9MM TOP HAT GROMMET

**XXL MODULE TRAY & LID - APXXL/T-L**

**RRP £14.95**



INCL. 9MM TOP HAT GROMMET

**1POT XL TRAY AND LID - AP300/XL/T-L**

**RRP £13.35**



INCL. 9MM TOP HAT GROMMET

**1POT TRAY AND LID - AP205/SQ/T-L/BLACK**

**RRP £10.20**



**EASY2GROW TRAY & LID - AP206/SQ/T-L/BLACK**

**RRP £11.35**



**50L FABRIC FLEXIPOT - APSMART/POT/13**

**RRP £10.25**



**35L FABRIC FLEXIPOT - APSMART/POT/9**

**RRP £8.80**



**20L FABRIC FLEXIPOT - APSMART/POT/5**

**RRP £6.80**



**25 L POT BLACK - AP300/XL/POT**

**RRP £7.50**



**25 L WHITEPOT - AP300/XL/POT/WHITE**

**RRP £9.25**



**15 L POT BLACK - AP210/SQ/BLACK**

**RRP £4.75**



**15 L WHITEPOT - AP210/SQ/WHITE**

**RRP £6.30**



**8.5 L POT BLACK - AP209/SQ/BLACK**

**RRP £3.55**



**8.5 L WHITEPOT - AP209/SQ/WHITE**

**RRP £5.15**



**LID FOR XXL MODULE TRAY - APXXL/LID**

**RRP £2.10**



**RING FOR XXL MODULE TRAY - APXXL/RING**

**RRP £3.95**



**LID FOR XL MODULE TRAY - AP300/XL/LID**

**RRP £2.10**



**LID FOR 1POT MODULE TRAY - AP205/SQ/LID**

**RRP £2.10**



**LID FOR EASY2GROW TRAY - AP211/SQ/LID**

**RRP £2.10**



For

**AUTO3/9XL BLANKING CAP - AUTOXL/CAP**

**RRP £7.50**



For AQUAvalve access holes on all tray systems

**BLUE ACCESS COVER - AUTO9XL/COVER**

**RRP £3.00**

# 9MM ACCESSORIES

FOR AUTOPOT WATERING SYSTEMS THAT USE AQUAVALVE5 & 9MM PIPE

**RRP = RECOMMENDED RETAIL PRICE**



9MM STRAIGHT CONNECTOR - PF900/9/1

RRP £0.50



9MM TEE CONNECTOR - PF901/9

RRP £0.60



16-9MM TEE CONNECTOR - PF949/T

RRP £2.00



9MM END STOP - PF940/9

RRP £0.40



9MM ELBOW CONNECTOR - PF903/9

RRP £0.50



9MM CROSS CONNECTOR - PF944/9

RRP £0.85



16-9MM CROSS CONNECTOR - PF949/X

RRP £2.50



9MM TOP HAT GROMMET - PF906/9

RRP £1.20



CO-EXTRUDED  
METRE MARKED

9MM PIPE (1.5M LENGTH) - PF100/9/1.5

RRP £1.95



CO-EXTRUDED  
METRE MARKED

9MM PIPE (30M LENGTH) - PF100/9/CX

RRP £37.80



9MM GOLF FILTER - PF905/GOLF/9

RRP £2.70



16MM-9MM IN-LINE FILTER - PF946/16MM-9MM

RRP £4.90



9MM IN-LINE TAP - PF902/9/1

RRP £2.70



AQUAVALVE5 - AQ100/5

RRP £14.90



AQUAVALVE5 BOTTOM FLOAT SILICONE - AQ102/5

RRP £0.25



AQUAVALVE5 TOP FLOAT SILICONE - AQ102/1

RRP £0.25



AQUAVALVE5 MAIN BODY - AQ106/5

RRP £6.50



EXCLUDES SILICONE

AQUAVALVE5 BOTTOM FLOAT - AQ108/5

RRP £3.50



EXCLUDES SILICONE

AQUAVALVE5 TOP FLOAT - AQ107/5

RRP £3.75



AQUAVALVE5 COLLAR - AQ104/5

RRP £0.60

# 16MM ACCESSORIES

SUITABLE FOR ANY AUTOPOT WATERING SYSTEM THAT USES 16MM PIPEWORK

**RRP = RECOMMENDED RETAIL PRICE**



**16MM STRAIGHT CONNECTOR - PF912/16**

RRP £1.30



**16MM TEE CONNECTOR - PF914/16**

RRP £1.30



**16MM ELBOW CONNECTOR - PF913/16**

RRP £1.15



**16MM END STOP - PF915/16**

RRP £1.25



CO-EXTRUDED  
METRE MARKED

**16MM PIPE (5M LENGTH) - 16MMPIPE/5/CX**

RRP £8.10



**16MM INLINE TAP - PF916/16**

RRP £5.35



**16MM CROSS CONNECTOR - PF916/X/1**

RRP £2.50



**16MM GROMMET (19MM HOLE RQD) PF919/16**

RRP £1.20



CO-EXTRUDED  
METRE MARKED

**16MM PIPE (30M LENGTH) - 16MMPIPE/30/CX**

RRP £48.60



**16MM INLINE FILTER - PF918/16**

RRP £6.90



**16MM CLICK-FIT FILTER - AP217/16**

RRP £11.75



**16MM CLICK-FIT PROFILTER - AP217/PRO**

RRP £16.45



**16MM PROFILTER - PROFILTER1**

RRP £13.60



**HOSE CONNECTOR - HOSE CONNECTOR 1/2"**

RRP £3.10



**TAP FOR ALL WATER BUTTS - AP224**

RRP £8.15



**FLEXITANK FITTING CAP - APFLEXI/CAP**

RRP £2.80



**FLEXITANK FITTING CLICK-FIT - APFLEXI/CLICK**

RRP £2.80



**FLEXITANK TAP - FLEXITAP/1**

RRP £5.60



**19MM GROMMET (23MM HOLE RQD) PF919/19**

RRP £1.25

*AutoPot Video Tutorials*



Guidance, hacks, inspiration. Scan the QR for a host of assembly and set up tips in our Tutorial Videos, or visit: [autopot.co.uk/3d-videos-and-animations/](http://autopot.co.uk/3d-videos-and-animations/)

# 6MM ACCESSORIES

INC. 16-6MM FITTINGS & FILTERS - FOR OLDER AUTOPOT WATERING SYSTEMS

**RRP = RECOMMENDED RETAIL PRICE**



6MM STRAIGHT CONNECTOR - PF900/6/1

RRP £0.50



6MM TEE CONNECTOR - PF901/4

RRP £0.60



16-6MM TEE CONNECTOR - PF945/T

RRP £2.00



6MM END STOP - PF940/6

RRP £0.40



6MM CROSS CONNECTOR - PF944/6

RRP £0.85



16-6MM CROSS CONNECTOR - PF945/X

RRP £2.50



6MM GROMMET - PF906/4

RRP £1.20



6MM GROMMET FOR GROMMETED TRAYS - PF906/T

RRP £1.20



6MM BLANKING GROMMET - PF906/P

RRP £1.20



UNMARKED  
NON CO-EXTRUDED

6MM PIPE (1.5M LENGTH) - PF100/1.5

RRP £1.20



UNMARKED  
NON CO-EXTRUDED

6MM HOSEPIPE 50M ROLL - PF100/6/1

RRP £37.80

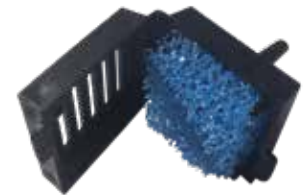

6MM GOLF FILTER COMPLETE - PF905/GOLF/1

RRP £2.70



GOLF FILTER MATERIAL - PF905/GOLF/MATERIAL

RRP £0.25



6MM INLINE TAP - PF902/6/1

RRP £2.70



AQUAVALVE - AQ100

RRP £14.90



PER SILICONE

AQUAVALVE SILICONE - AQ102/1

RRP £0.25



AQUAVALVE MAIN BODY - AQ106/1

RRP £6.50



EXCLUDES SILICONE

AQUAVALVE BOTTOM FLOAT - AQ108/1

RRP £3.50



EXCLUDES SILICONE

AQUAVALVE TOP FLOAT - AQ107/1

RRP £3.75



AQUAVALVE COLLAR - AQ104/1

RRP £0.60

# SYSTEMS SPARES

**RRP = RECOMMENDED RETAIL PRICE**



Root Control Sheet for Tray2grow

**TRAY2GROW ROOT CTRL - T2G/RCD/SHEET**

**RRP £7.95**



Capillary Matting for Tray2grow

**CAPILLARY MAT - T2G/CAPILLARY/MAT**

**RRP £12.40**



Root Control Sheet for easy2grow Propagate

Fits **COCOMAT** 116cm x 51cm  
**ROOT CTRL SHEET - APRCD/SHEET/116X51**

**RRP £13.60**



Fits **COCOMAT** 51cm x 30cm  
**ROOT CTRL SHEET - APRCD/SHEET/51X30**

**RRP £4.40**

250mm Ø Root Ctrl Sheet for recirculating systems



**250MM ROOT CTRL DISC - AP250/IWS**

**RRP £1.50**



170mm Ø Root Ctrl Sheet for recirculating systems

**170MM ROOT CTRL DISC - AP170/IWS**

**RRP £1.25**



Root Control Sheet for 1Pot XL / Auto 3XL / Auto9XL

**ROOT CTRL DISC ROUND - AP300/XL/RCD**

**RRP £1.60**



Root Control Sheet for 1Pot / Auto8

**ROOT CTRL DISC SQ - AP229/SQ/1**

**RRP £1.10**



Marix Disc for 1Pot / Auto8 / easy2grow

**MARIX DISC SQUARE - AP225/SQ/1**

**RRP £0.55**

Root Ctrl PotSock for 50L Fabric Pots (as used in XXL)



**POTSOCK FOR 50L POT - APRCD/SOCK/50LFP**

**RRP £6.00**



Root Ctrl PotSock for 35L Fabric Pots (as used in XXL)

**POTSOCK FOR 35L POT - APRCD/SOCK/35LFP**

**RRP £5.30**



Root Ctrl PotSock for 1Pot XL / Auto3/9XL / XL FlexiPot

**POTSOCK ROUND - APRCD/SOCK/XL**

**RRP £4.20**



Root Ctrl PotSock for 1Pot / easy2grow / Auto8

**POTSOCK SQUARE - APRCD/SOCK/SQ**

**RRP £2.70**



**AQUAVALVE POTSOCK - APRCD/SOCK/AQ**

**RRP £1.50**

Use if placing AQUAvalve in open trays with fabric pots



**AQUAVALVE POTSOCK KIT-AQSOCK/PLATE/KIT**

**RRP £7.50**



To weigh down AQUAvalve PotSocks in open trays

**AQUAVALVE POTSOCK PLATE - AQSOCK/PLATE**

**RRP £6.00**

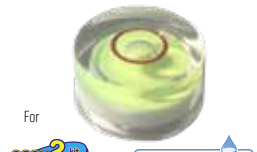

For easy2grow Propagate AQUAvalve

**SPIRIT LEVEL - CIRCULAR LEVEL**

**RRP £1.15**



**AQUAVALVE COVER - AQ101/N**

**RRP £6.25**



**AQUAVALVE TOP FLOAT DISC - AQ105**

**RRP £0.55**



**47L RESERVOIR STAND - 60007**

**RRP £11.35**



**47L/30L RES. LID - AP219/LID/BLACK**

**RRP £5.15**



**47L RESERVOIR - AP219/BLACK**

**RRP £15.80**



Complete with lid and 9mm Top Hat Grommet

**47 L RESERVOIR - AP219/T-L/BLACK**

**RRP £17.60**



**30 L RESERVOIR - AP218/TANK/BLACK**

**RRP £12.00**



Complete with lid and 9mm Top Hat Grommet

**30 L RESERVOIR - AP218/T-L/BLACK**

**RRP £15.35**

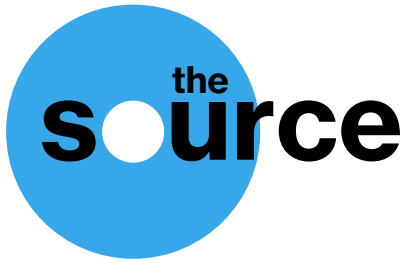

**A CLEAN, EFFICIENT, HIGH-PURITY NUTRIENT REGIME**

**COMPREHENSIVE SIX-PRODUCT RANGE REFINED THROUGH YEARS OF TESTING & USE**

**OPTIMISED FOR USE WITH AUTOPOT WATERING SYSTEMS**



## **PURE PLANT NUTRITION**

Go to the Source, for plant nutrition in its purest form. It's a simple concept. Clean, highly concentrated fertilisers for effective, efficient performance. The biostimulants that comprise the Source range rigorously adhere to your plants needs, bringing you improved plant health, increased yield, and greater returns.

## **READY FOR ANYTHING**

Extensively proven by the UK's leading horticultural universities, the Source's pure synergy with plant requirements has produced outstanding results with all growing media and all cultivation systems. Paired with AutoPot Watering Systems the Source's efficiency is elevated from exceptional to unparalleled.

## **BEHIND THE MAGIC**

Every decent result is entirely dependent on pure, efficient inputs. All Source fertilisers and biostimulants are composed of 100% natural, plant-extracted ingredients, with no artificial PGR's. For ease of use the range has been developed for hard or soft water suitability and performs in soil, coco, or hydro grow media.

**E: MAIL@AUTOPOT.CO.UK**

**🌐 AUTOPOT.CO.UK**

**📷 @AUTOPOT\_GLOBAL**

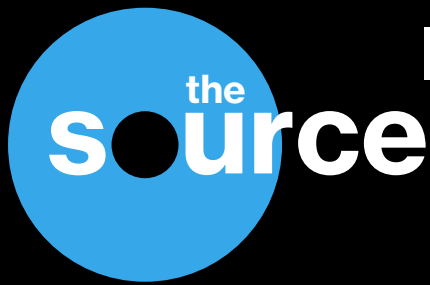

SUITABLE FOR USE WITH ALL CULTIVATION METHODS, PLANT TYPES & SUBSTRATES

HIGHLY RECOMMENDED FOR ALL AUTOPOT WATERING SYSTEMS

DESIGNED TO BE USED AS A COMPLETE SUITE OF NUTRIENTS & BIOSTIMULANTS



### Gro A/B Growth Stimulator

Get relentless, rapid, uniform growth with Gro. This beautifully balanced veg stage fertiliser ensures your plants develop fully, remain healthy, and are well suited to heavy harvests. Always sufficient but never excessive, Gro's ingredients provide a fantastically responsive nutritional regime for all plant types.

SKU	SF/GS/01	SF/GS/02	SF/GS/03
RRP	250ML £9.95	1 L £19.95	5 L £59.95



### Flo A/B Growth Stimulator

Comprehensive and readily available for uptake, Flo's chelated elements and plant extracted ingredients are calibrated to function harmoniously and in sequence. They enhance flower and fruit development, oil production, and sugar concentrations whilst maintaining robust growth.

SKU	SF/FS/01	SF/FS/02	SF/FS/03
RRP	250ML £9.95	1 L £19.95	5 L £59.95



### Delta Boost Stimulator

Fertile as a river delta, this all-stage Boost Stimulator inspires verdant, vigorous growth and helps produce the heaviest, most flavoursome fruits and flowers imaginable. Using algal extracts, plant sourced amino acids, natural plant steroids and poly-glucosides, Delta fortifies plants against pests and diseases.

SKU	SF/BD/01	SF/BD/02	SF/BD/03
RRP	250ML £24.95	1 L £62.95	5 L £219.95



### Alluvium PK Stimulator

An innovative, highly concentrated PK Stimulator for the flowering and fruiting stage with a balanced NPK of 0-18-20. Featuring a rich, high purity potassium and phosphorus content, Alluvium encourages prolific flowering and produces fruit of unrivalled taste and size.

SKU	SF/PK/01	SF/PK/02	SF/PK/03
RRP	250ML £19.95	1 L £49.95	5 L £174.95



### Elements CalMag Stimulator

Elements gets you on a roll. This powerful CalMag bio-stimulant fortifies your plants, keeps vital processes running at full tilt, and encourages rapid, healthy new growth. A more fully functioning plant is created, capable of ever more vigorous onward development.

SKU	SF/CE/01	SF/CE/02	SF/CE/03
RRP	250ML £8.95	1 L £17.95	5 L £52.95



### Origin Root Stimulator

Origin cultivates a rhizosphere that is healthy, ideal for nutrient absorption, and highly conducive to productive growth. This powerful stimulator helps your plant develop extensive root structures of immense mass that can easily access available moisture and make optimum use of nutrients.

SKU	SF/RO/01	SF/RO/02	SF/RO/03
RRP	250ML £19.95	1 L £49.95	5 L £174.95

### Complete Source Starter Kits »

Only when used in unison does the Source fertiliser range truly deliver it's full, sequenced, harmonious, high-yielding functionality. Source Complete Starter Kits allow you to sample this coordinated performance for yourself.

8x 250ml bottles: 1x Gro A, 1x Gro B, 1x Flo A, 1x Flo B, 1x Delta, 1x Alluvium, 1x Elements, 1x Origin

SKU: SF/FR/01	RRP	£89.95
---------------	-----	--------



### Source Feed Charts



Go to the Source for feeding guidance with all plants, all cultivation methods, and all grow media

RRP = RECOMMENDED RETAIL PRICE

SHOP NOW AT SOURCEFERTILISER.COM

@AUTOPOTUK

AUTOPOT.CO.UK

@AUTOPOTSYSTEMS

# RAPID ROOTS

# ORGANIC ROOT GEL



« RAPID ROOTS 50ML - PS/RG/001

RRP £12.00

Strike rate gold. Rapid Roots 100% organic rooting gel fortifies your cuttings with a rich supply of natural plant hormones, vitamins, trace elements, and other nutrients.

Completely free from synthetics, this astonishingly effective new product draws its strength from high quality seaweed extracts that also instil hardiness and drought resistance.

» 100% Organic

» Free from synthetics

» Packed with plant hormones

» Preserves rich content of extracts

» Improves drought resistance

» Features uptake-boosting Leonardite

RAPID ROOTS 200ML - PS/RG/002 »

RRP £43.20



1 Dispense Rapid Roots into a small container.



2 Take your cutting and coat the bottom 2cm of the stem.



3 Transfer immediately into your rooting media of choice



4 Place inside a propagator and maintain in moist conditions.



easy2grow Liquid Feed - available in 1L, 5L, and 20L sizes

RRP

1L £7.75

5L £22.75

20L £64.20

# EASY2GROW FEED



A clean, stable, high-performance one-part nutrient optimised for use in all AutoPot Watering Systems

RRP = RECOMMENDED RETAIL PRICE

SEE PAGE 12 FOR RESERVOIR & WATER TIPS

E: MAIL@AUTOPOT.CO.UK

🌐 AUTOPOT.CO.UK

📷 @AUTOPOT\_GLOBAL





# BIOTABS ORGANICS



**BOOM BOOM SPRAY 100ML**

BIOTABS/BOOMBOOM/100

RRP £20.00



**BOOM BOOM SPRAY 250ML**

BIOTABS/BOOMBOOM/250

RRP £31.00



**GUERRILLA BOX**

BIOTABS/GUERRILABOX

RRP £30.25



**GUERRILLA JUICE - 500ML**

BIOTABS/GUERRILLAJUICE/500

RRP £15.90



**GUERRILLA TABS - 20 PCS**

BIOTABS/GUERRILLATABS/20

RRP £13.55



**GUERRILLA TABS - 200 PCS**

BIOTABS/GUERRILLATABS/200

RRP £122.00



**SILICIUM FLASH 2.5L**

BIOTABS/SILICIUMFLASH/2500

RRP £29.90



**SILICIUM FLASH 9L**

BIOTABS/SILICIUMFLASH/9000

RRP £99.90



**PK BOOST TEA - 2KG**

BIOTABS/PKBOOSTTEA/2

RRP £55.00



**PK BOOST TEA - 8KG**

BIOTABS/PKBOOSTTEA/8

RRP £179.00



**PK 5-8 500ML**

BIOTABS/PK5-8/500

RRP £27.50



**PK 5-8 1L**

BIOTABS/PK5-8/1000

RRP £47.50



**PK 5-8 5L**

BIOTABS/PK5-8/5000

RRP £149.50



**STARTREX 1.5KG**

BIOTABS/STARTREX/1500

RRP £22.50



**STARTREX 5KG**

BIOTABS/STARTREX/5000

RRP £67.50



**BACTREX 50G**

BIOTABS/BACTREX/50

RRP £26.00



**BACTREX 250G**

BIOTABS/BACTREX/250

RRP £108.50



**BIOTABS - 10 TABS**

BIOTABS/TABS/10

RRP £14.95



**BIOTABS - 100 TABS**

BIOTABS/TABS/100

RRP £125.00



**MYCOTREX 100G**

BIOTABS/MYCOTREX/100

RRP £35.90



**MYCOTREX 500G**

BIOTABS/MYCOTREX/500

RRP £145.00



**ORGATREX 1L**

BIOTABS/ORGATREX/1000

RRP £17.90



**ORGATREX 5L**

BIOTABS/ORGATREX/5000

RRP £71.50



**BIOTABS SINGLE STARTER PACK**

BIOTABS/SIN/1

RRP £59.95

*Contents: 250g Startrex, 50g Mycotrex, 25g Bactrex, 10 BioTabs, 250ml Orgatrex*

**RRP = RECOMMENDED RETAIL PRICE**

**SEE PAGES 8-9 FOR NUTRIENT INFORMATION**

@AUTOPOTUK

AUTOPOT.CO.UK

@AUTOPOTSYSTEMS



# AUTOPOT GROWERS

## THE OXFORDSHIRE CHILLI FARM, UK

The Oxfordshire Chilli Farm (Plantasia) have been growing capsicums using AutoPot Watering Systems for 10 years. AutoPot offer growing solutions to each variety under cultivation. For large 'super-hot' varieties the XL System provides ideal size and adjustability. Habanero and Scotch Bonnets are served by the 1Pot System. Sweet peppers are grown using the high-wire method in easy2grow with 15L pots instead of the 8.5L as this suits these capsicums better. For further details of Plantasia's current chilli selection, nutrient and substrate combinations and greenhouse layouts visit [www.plantasia.co.uk](http://www.plantasia.co.uk)



**Crop Type:** Capsicum Chinense var. 7Pot Primo  
**Greenhouse size:** 1000sq m Keder House  
**AutoPot Systems Used:** easy2Propagate, easy2grow, 1Pot, 1Pot XL  
**Crops per year:** 1 **Growing Media:** Coco/Soil  
**Yield:** 4kg/sq m/year

## MEDWYN WILLIAMS - MEDWYNS OF ANGLESEY

A 13-time RHS Chelsea Gold Medallist, Medwyn Williams is famed for cornucopias of immaculately grown, specimen vegetables. For him the chief prospects of using AutoPot were savings in time and costs, without ever compromising on plant health or veg quality. Medwyn was also intrigued by the potential of AutoPot to act as a leveller where competition growing is concerned. Two years of using the systems have brought about his latest Gold Medal, and confirmed his suspicion; that AutoPot brings the growing of large, exhibition-quality veg onto a level playing field. He predicts that, in future, far more entries on show benches will be AutoPot grown.



**Crop Type:** Leeks, Onions, Potatoes (with AutoPot)  
**Greenhouse Size:** 500 sq m  
**AutoPot Systems Used:** 1Pot XL, 1Pot, easy2grow, easy2propagate **Growing Media:** 100% Coco Coir  
**Crops Per Year:** Multiple **Nutrients Used:** Mineral  
**Follow:** Twitter/Insta

## KUNYA BEACH, KENYA

Kunya Beach Nursery is located in an important horticultural region of Africa. Growers in the area must meet stringent government criteria given the existing demands on local resources. AutoPot Watering Systems easily meet these criteria thanks to their water efficiency and power-free operation. For this reason the nursery has attracted a great deal of government and commercial interest. Sustainable horticulture is seen as a great driver for potential local employment. Furthermore the market for affordable, reliable crops is vast and, by utilising such systems, the overheads are minimal.



**Crop Type:** Tomatoes, Peppers, Melons  
**Greenhouse Size:** 1200 sq m  
**AutoPot Systems Used:** easy2grow, WhitePot  
**Growing Media:** Pumice and Cocopeat 50/50  
**Crops Per Year:** 2 **Nutrients Used:** Mineral Compound  
**Yield Per Month:** 5kg/sq m

E: [MAIL@AUTOPOT.CO.UK](mailto:MAIL@AUTOPOT.CO.UK)

[AUTOPOT.CO.UK](http://AUTOPOT.CO.UK)

[@AUTOPOT\\_GLOBAL](https://www.instagram.com/AUTOPOT_GLOBAL)



# STORE RESOURCES

## PUT YOUR STORE ON THE MAP!

AutoPot Stockist? Want to be at the fingertips of customers everywhere? Join our Store Finder - FREE!

How? **1** Simply scan the QR **2** Submit your application online **3** We put you on the map.

Interested? Visit [autopot.co.uk/store-locator-application-form-uk/](http://autopot.co.uk/store-locator-application-form-uk/) or scan the QR code here:

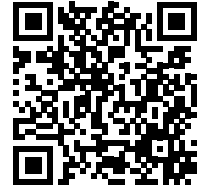

## IN-STORE DISPLAYS

Our Reps are more than happy to help you fly the flag for AutoPot. Talk to them about our vast and varied range of branded in-store marketing materials, all designed to see you enhance sales and much of it customisable. Co-branding with your logo? Why not? To fit your space? Can do. A huge archive of glorious AutoPot in-action images to work with? Absolutely.

## THE RESOURCE CENTRE

Get product images, systems info, diagrams, Quick-Guides and more - all via the Resource Centre at [autopot.co.uk](http://autopot.co.uk).

Whether you're building a website or crafting print literature we want to see you get the best out of our resources.

Get the required password by emailing [mail@autopot.co.uk](mailto:mail@autopot.co.uk). Alternatively reach us by scanning the QR here:

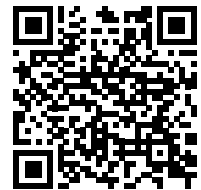

## VIDEOS FOR WEB AND IN-STORE

We know an increasing number of stores are looking to promote AutoPot in-store or online via video content. In order to assist we've assembled an array of videos ready to be embedded, uploaded via file-copies, or played via file in-store. Get in touch with your Rep to request access to a wealth of great content- assembly videos, animations, and, in the near-future, tutorial videos showing your customers how to get the most out of their systems.

## THE AUTOPOT NEWSLETTER

Growers from around the world sharing their genius techniques with AutoPot, the latest product news and grow tests with myriad producers combining forces with AutoPot, the full rundown on where to find us on the show circuit, special offers, unmissable store resources, and the latest on the U.K.'s premier trade-hydroponic event The AutoPot Summer Social - for all this joy and more sign up now to the AutoPot Newsletter - scan the QR here:

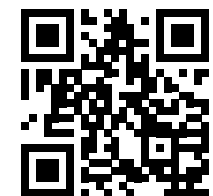

## FOLLOW US FOR THE LATEST

As-it-happens updates on everything AutoPot and a great opportunity to see your store featured on our feeds. Our Reps are plenty snap-happy when they make their rounds and we enjoy sharing your displays and in-store innovations with our following. Every page herein includes our tags in the footer.



## Available worldwide



**manufacturer**

Email: [mail@autopot.co.uk](mailto:mail@autopot.co.uk)  
Web: [www.autopot.co.uk](http://www.autopot.co.uk)



**distributor**

Email: [info@autopot.asia](mailto:info@autopot.asia)  
Web: [www.autopot.asia](http://www.autopot.asia)



**distributor**

Email: [info@autopot.nl](mailto:info@autopot.nl)  
Web: [www.autopot.nl](http://www.autopot.nl)



**distributor**

Email: [info@autopot-canada.ca](mailto:info@autopot-canada.ca)  
Web: [www.autopot-canada.ca](http://www.autopot-canada.ca)

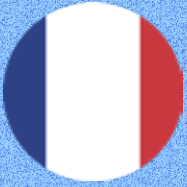

**distributor**

Email: [autopot.france@gmail.com](mailto:autopot.france@gmail.com)  
Web: [www.autopot.fr](http://www.autopot.fr)



**distributor**

Email: [info@autopot-usa.com](mailto:info@autopot-usa.com)  
Web: [www.autopot-usa.com](http://www.autopot-usa.com)



**distributor**

Email: [mail@autopot.es](mailto:mail@autopot.es)  
Web: [www.autopot.es](http://www.autopot.es)

AutoPot Global Ltd  
Unit 5, 108 Hawley Lane,  
Farnborough, Hampshire  
GU14 8JE, UNITED KINGDOM

Tel: +44 (0)1276 534900

Email: [mail@autopot.co.uk](mailto:mail@autopot.co.uk)  
Web: [www.autopot.co.uk](http://www.autopot.co.uk)

 [autopot\\_global](https://www.instagram.com/autopot_global)

 [@AutoPotSystems](https://www.facebook.com/AutoPotSystems)

 [autopotuk](https://www.youtube.com/autopotuk)

©AutoPot Global Ltd 2023

All prices correct 1st January 2023

